

The influence of Parathyroid hormone treatment on implant fixation

Henrik Daugaard

This review has been accepted as a thesis together with 3 previously published papers by University of Aarhus 28th October 2010 and defended on 10th December 2010.

Tutor(s): Kjeld Soballe, Brian Elmengaard, Troels T. Andreassen, Joan E. Bechtold.

Official opponents: Erik Fink Eriksen, Benny Dahl, Ivan Hvid.

Correspondence: Department of Orthopaedics, Aarhus University Hospital, Tage Hansens Gade 2, 8000 Aarhus, Denmark.

E-mail: h.daugaard@dadlnet.dk

Dan Med Bull 2011;58(9):B4317

THE 3 ORIGINAL PAPERS ARE

Daugaard H, Elmengaard B, Andreassen TT, Lamberg A, Bechtold JE, Soballe K. Systemic intermittent parathyroid hormone treatment improves new bone of press-fit inserted implants in cancellous bone. *Acta Orthopaedica*. Accepted for publication.

Daugaard H, Elmengaard B, Andreassen TT, Lamberg A, Bechtold JE, Soballe K. Parathyroid hormone treatment increases fixation of orthopaedic implants with gap healing. A biomechanical and histomorphometric canine study of porous coated titanium alloy implants in cancellous bone. *Calcif Tissue Int*. 2011 Apr;88(4):294-303. Epub 2011 Jan 21.

Daugaard H, Elmengaard B, Andreassen TT, Baas J, Bechtold JE, Soballe K. The combined effect of parathyroid hormone treatment and bone graft on implant fixation. *J Bone Joint Surg Br*. 2011 Jan;93(1):131-9.

1. BACKGROUND

TOTAL HIP ARTHROPLASTY

Total hip replacement restores the mobility and quality of life in an individual with a painful and deformed hip joint (1).

History of total hip arthroplasty

Over the past centuries the advances in hip joint surgery has evolved from the earliest *resection* arthroplasties through *inter-*

positional membrane techniques to the successful *total hip arthroplasty (THA)* as known today in which the entire joint is replaced (2, 3).

The first salvage procedure of a degenerated painful hip joint was the removal of the affected femoral and acetabular bone by White in 1821. Later, in 1826 Barton treated an ankylosed hip with a trochanteric osteotomy creating a false joint (a pseudoarthrosis). Although immediate relief was apparent long-term outcome was unpredictable.

Further need for improvement in mobility introduced from 1830s and onwards strategies of interposing membranes between the femoral head and the acetabulum (wood, rubber, wax, gold foil, pig bladders). In the early 1900s the use of the individuals own peri-implant soft tissues (fascia lata, muscle etc.) became popular. However, failure occurred due to insufficiency in strength withstanding the stresses of weight bearing and intra-articular pressure. In 1932 Smith Petersen introduced the synthetic interpositional arthroplasty with a mould prosthesis (4). A cup was fitted on the existing femoral head articulating with both joint surfaces as a synovial/cartilage-like layer "guiding nature's repair". The moulded cups were of celluloid (Bakelite) or glass (Pyrex), but sensitive to material fracture. These cups were followed by Vitallium (Co-Cr-Mo) when Venable in 1937 set the standard in material properties of implants. The same year the Aufranc cup was introduced as a further anatomic design. These mould interpositional arthroplasties provided the first predictable results in hip joint surgery.

The earliest recorded attempt of the total hip arthroplasty (THA) was replacement of one half of the hip joint with a femoral head prosthesis (hemiarthroplasty). In 1891 Glück used a femoral head of ivory and in 1919 Delbet a rubber femoral prosthesis. However, until the progress in metallurgy in the 1940's the THA procedures were rare and unpopular compared to mould arthroplasties. In 1946 the Judet brothers introduced a short-stem femoral prosthesis of Co-Cr alloy and others adapted the implant design (Thompson 1951). These and subsequent short-stem implants were however subject to high shear stress and resulted in early loosening and failure. Longer stems that provided less stress concentration gradually replaced short-stem designs. In 1942 the Moore prosthesis was introduced. The original prosthesis was a femoral head replacement with a large fixed head of Vitallium, which was secured to the resected end of the femoral shaft. Long-term success was however not achieved until 1950 when Moore inserted the femoral replacement within the medullary canal and with only partial resection of the femoral neck. This technique is a fundamental of today's THA in which weight-

bearing forces are transferred to the femur through an intramedullary stem (5). In 1952 Moore refined the implant featuring a proximally fenestrated stem to allow bone ingrowth. The modern artificial joint of today owes much to the work of Sir Charnley, who replaced both the acetabulum and the femoral head in a total hip replacement. Although Wiles in 1938 and McKee in 1951 described the first attempts of THA, the introduction of Low Friction Arthroplasty by Sir Charnley far surpassed these by the 1970s. Charnley's original design in 1960 (6) consisted of three parts with synovial fluid lubrication: 1) a metal femoral component of stainless steel (a long femur stem) with a non-modular artificial femoral head articulating with 2) an artificial acetabular component (cup), with both components fixed to the bone using 3) poly(methylmethacrylate) (PMMA) (cement) as a bone filler. The cup was originally of Teflon (polytetrafluoroethylene, PTFE) which caused significant wear debris and bone resorption (osteolysis). It was replaced in 1962 with Ultra High Molecular Weight Polyethylene (UHMWPE), a Co-Cr alloy stem, and an articulating small head reducing wear. The Charnley prosthesis showed in general good mid-term results. Ten years after the introduction some implants showed mechanical loosening due to osteolysis and this was suspected to be caused by cement particles (7, 8). Under this impression implants inserted without cement prospered in the 1980s and were further refined with roughened implant surfaces facilitating bone ingrowth.

Present total hip arthroplasty

Current *standard THA* consists of

1. a *femoral stem* of titanium or cobalt-chromium (Co-Cr) alloy with insertion in interference fit or with PMMA as means of fixation
2. connected to a modular *femoral head* of Co-Cr alloy or ceramic and
3. articulating with an *acetabular liner* of UHMWPE or ceramic. The articulation may be cemented into the acetabulum or fitted into
4. an *acetabular cup* of titanium, Co-Cr alloy or tantalum and press-fit secured in the acetabulum.

The long-term survival of hip implants depends on how well the implant becomes fixed from the outset of the procedure. Two methods are now routinely used to attain initial implant fixation: 1) cementing the implant in the bone using polymethylmethacrylate (PMMA), 2) press-fitting the implant into the prepared bone site with subsequent bone ingrowth into the implant porosity.

In Denmark, of the 7473 primary hip arthroplasties performed in year 2008 59.1% were non-cemented, 17.9% hybrids (one prosthetic component cemented, the other uncemented), and 22.9% cemented (9). Of the 534 cup revisions performed in 2008 83 % were uncemented and 73 % in the 486 femur stem revisions (9).

For young more active patients, non-cemented implants are preferable. Reports from the Norwegian Arthroplasty Register (10) and other studies (11) show better survival of non-cemented as to cemented femur stems in patients younger than 60 years old. In general uncemented femoral components have high mid-term results (11, 12), but higher failure rate has been reported of the cementless acetabular cups compared to the femoral stem, with acetabular components having less bone ingrowth (10, 12, 13).

The functional life of a prosthetic total joint is influenced by a large number of factors (14), among others

- Patient related
 - host bone quality and pathology
 - load conditions
 - patient activity
 - underlying disease
- Technical aspects
 - surgical technique
 - stability
 - surgeon
- Prosthesis
 - geometry and design
 - composition
 - elastic modulus
 - corrosion resistance
 - biocompatibility
 - surface texture

The typical total hip replacement enjoys in general a high success rate, but outcome differs depending on subgroup evaluated. The ten-year implant survival rate for patients over 75 years is 95%, but only 88% for patients under 50 years of age according to the Danish Hip Arthroplasty Registry (9).

Among the risk factors, age less than 60 years old is still a strong predictor of long-term implant failure (14) and for younger patients the risk of implant failure is still unsatisfactorily high.

The overall objective of this thesis is to improve the long-term survival of a prosthetic total joint by improving the initial implant integration into bone.

It seems relevant to enhance the initial fixation by adjuvant therapy.

Implant composition

The goal of an orthopaedic implant material is to obtain long-term implant fixation and implant material properties comparable with the bone environment. Bone is viscoelastic and anisotropic (15, 16) and the bone bed varies in which a prosthesis is inserted. The femur component of the THA is primarily fixed in the proximal femur in a bone environment abundant in cancellous bone. The acetabular cup is inserted in the cancellous or subchondral bone of the acetabulum.

Metals used for uncemented implants include

1. titanium (Ti) as commercially pure titanium (CPTi) or titanium alloy, predominantly Ti-6AL-4V,
2. cobalt-chromium (Co-Cr) alloys, most widespread Co-Cr-Mo,
3. stainless steel, or
4. tantalum

Metals differ in properties and biocompatibility. Implants made of Co-Cr alloys are harder, more wear resistant, and with lower biocompatibility than Ti alloys (3, 17). Ti alloys have superior mechanical and corrosive properties than CPTi, but CPTi has relatively higher ductility and biocompatibility (18). Whereas the elastic modulus of Co-Cr alloys (210-253 GPa) considerably exceeds that of cortical bone (15-40 GPa), the modulus of Ti alloys (116GPa) and CPTi (110 GPa) are closer and thereby provide less non-physiological bone remodelling (stress shielding) (3). In general, the Ti alloys are used as stem and cup in the THA components of uncemented prosthesis, the CPTi in some as coatings, and Co-Cr alloys in the THA articulation. Only short-term success

has been achieved using stainless steel in uncemented hip arthroplasty (19).

Implant surface

The surfaces used for uncemented implants include

1. a smooth surface or
2. a roughened surface. The roughness is achieved by
 - a. a porous coat. The porosity may consist of
 - i. plasma spraying heated Ti-alloy powder on to the implant surface,
 - ii. beads sintered to the implant surface,
 - iii. diffusion bonding of Ti wires moulded into a fibre mesh, or
 - iv. trabecular metal structure
 - b. grit-blasting
 - c. etching

Uncemented implants with a smooth surface on the entire component have a high failure rate and are abandoned (10). To help achieve adequate initial fixation without the use of cemented implants porosity provides a rough surface that secures the initial stability at the time of insertion, and a structure for subsequent bone ingrowth for secondary fixation. Comparative studies on porous coats are limited (20, 21). The optimum pore size for facilitating bone ingrowth is controversial. Openings of 50 µm and 400 µm in diameter have been shown to provide good bone ingrowth and fixation strength (22). Acetabulum components often have a porous coat. Femoral components have either a porous coat along the whole length, or a proximal porous coating with the distal portion of the implant being gritblasted or smooth.

The implants used in this PhD thesis are Ti-alloy with a porous coat of plasma spray and inserted non-cemented in bone.

Peri-implant endosseous healing

The insertion of a prosthesis induces a bone injury. Subsequent bone repair is required in order to integrate the implant into the bone. A few retrieval studies show that some well-functioning acetabular and femoral stems may become fixed by fibrous tissue instead of bone ingrowth (5, 23). During load of a prosthesis wear of the components occur. This may induce wear osteolysis and implant loosening. By stimulating bone ingrowth to the implant surface a seal of tightly-bonded bone on the implant inhibits peri-implant migration of wear particles (24).

Ideal conditions for peri-implant bone healing require functional stability at insertion. A modest bone-implant motion impairs the process of bone growth while a more extensive motion (>150 µm) induces a fibrous encapsulation (25) with a layer of reactive bone on the fibrous membrane (26). Inserting the uncemented prosthesis in press-fit with surrounding bone provides a primary fixation, while secondary fixation is acquired by subsequent bone-integration.

The *osseointegration* of an implant is a time related process in which the initial regeneration of new bone is followed by life-long bone remodelling. The definition of osseointegration varies with the observer's perspective and evaluation options. *Clinically*, osseointegration is defined as the asymptomatic rigid fixation of alloplastic material maintained in bone over time during functional loading (27). In clinical implant studies the degree of rigid fixation can be evaluated by radio-stereometric-analysis (RSA) (28). However, on the daily basis the clinician is faced with the challenge of identifying successful osseointegration by an x-ray

image in which the implant may seem in direct contact with bone at the feasible macroscopic resolution level (29). The original definition by Brånemark (30) and Albrektsson (31) provides the *histology* of implant anchorage on the light microscopy level and defines osseointegration as direct connection of osseous tissue to the implant surface without intervening (connective) tissue. At the level of transmission electron microscopy *ultrastructural* investigations have challenged the light microscope perception of bone in continuum with the implant revealing an intervening amorphous matrix between bone and implant interface (27).

A number of factors can be defined in describing the bone formative process.

Osteogenesis is the process of bone formation in which new bone is laid down by osteoblasts.

Osteoinduction and osteoconduction are prerequisites for osseointegration.

Osteoinduction is the process by which osteogenesis is induced (32). It describes the recruitment of perivascular primitive undifferentiated pluripotent mesenchymal cells, and the stimulation of these cells to develop into osteoprogenitor cells and osteoblasts. Inductive agents induce heterotopic osteogenesis (33), that is, stimulate bone formation extraskeletally by recruitment of mesenchymal cells without the presence of osteogenic and osteoconductive substances. However, in an orthotopic bone site differentiation between bone induction and conduction may be more vague. Of osteoinductive agents bone morphogenetic proteins BMP-7 (OP-1), BMP-2 as well as TGF-β induce bone growth (34).

Osteoconduction describes the process by which bone grows on a surface. It is characterised by an initial invasion of fibrovascular tissue along the surface followed by new bone formation. It includes the recruitment and migration of differentiated cells through the residue of the peri-implant blood clot placing differentiated osteogenic cells at the surface. An osteoconductive surface permits bone growth (32). Bone grafts are osteoconductive. Implant materials of high conductive biocompatibility are the titanium compounds, CPTi better than and Ti-alloy (35), whereas copper and silver show less.

Rasping and reaming damage trabeculae during implant site preparation. In this respect fracture healing and peri-implant healing exhibit many similarities. However the presence of an implant induces an additional mode of healing (36) in an environment characterised by intramembranous ossification.

The osseointegration process is triggered by *trauma* from the implantation procedure and by the *implant*. In implants of adequate stability the integration process opens with the formation of a hematoma, then a reactive phase of inflammation and granulation tissue, followed by a reparative phase of woven bone formation, which is later remodelled.

- *Hematoma*. Preparing the bone site causes bleeding in the peri-implant space. The coagulation pathway is activated. The blood clot acts as physical barrier to further bleeding and a provisional scaffold for cell migration. Platelets adhere, become activated, degranulate and release multiple growth factors (platelet-derived growth factor (PDGF), transforming growth factor beta (TGF-β)), cytokines and vasoactive substances (serotonin, histamine). These chemotactic and mitogenic factors play an important role in accelerating the subsequent bone regenerative cascade in which inflammatory, endothelial,

mesenchymal, and bone cells are recruited, migrate, and proliferate (34, 37-39).

- **Reactive phase.** The hematoma is gradually transformed into granulation tissue by angiogenesis and fibroplasia accompanied by an inflammatory response. Neutrophil leucocyt infiltration is followed by influx of monocytes influenced by PDGF (37) and thrombin (40). Monocytes differentiate into macrophages for phagocytosis of wound debris. The initial ischemia and anaerobe metabolism leads to local acidity which in itself also is chemotactic to endothelial and mesenchymal cells (41). New blood vessels are initiated. Bone conduction and formation depends on an adequate blood supply. Influenced by both PDGF and TGF- β fibroblasts migrate and proliferate forming a loosely woven connective tissue supporting vascular growth of cells (42, 43).
- **Reparative phase.** Osteogenesis relies on previous osteoinduction, since pre-existing preosteoblasts/osteoblasts only contribute minimally in the new bone formation (44, 45). Surface osteoinduction is considered essential, although at the same time as a reparative reaction the damaged bone surfaces at the prepared site provide the osteogenic cells that lay down new bone matrix on the old bone. Undifferentiated cells are recruited to form osteoprogenitor cells (46) and develop into bone forming cells. This is affected by the growth factor bone morphogenetic proteins (BMP-2 and BMP-7), which are the only known osseointductive agents and are released in response to the trauma of implant insertion (33, 34, 47). PDGF modulates the proliferation of osteoblasts (48, 49). The growth factors released from platelets and injured bone tissue stimulates synthesis of additional factors by the osteoblasts, thereby maintaining the healing process (34). Osteoblasts lay down woven bone as osteoid containing mainly collagen type I with subsequent mineralization and woven bone formation.

At the implant interface the initial hemorrhagia leads to a coating of the surface with plasma proteins (50). An implant surface, which is microtextured, improves the osteoconductive activity (51-54). Differentiating osteogenic cells initiate bone deposition. Collagen is synthesized onto and mineralized to produce morphologically identifiable bone matrix. However, an amorphous matrix layer (20-50 to 500 nm thick) can be visualized directly on the titanium implant surface (27, 55). This amorphous layer has been associated with both mineralised (56) and non-mineralised tissue (27) in which the innermost 20-40 nm seem not to contain collagen and the outermost have randomly arranged filaments. Non-collagen-proteins have been identified as osteopontin, bone sialoprotein, proteoglycans and glucosaminoglycans (57, 58). With titanium alloy implants similar zones of the amorphous matrix of varying magnitude are described showing an organization at the implant interface divergent from that of the surrounding bone (59). The amorphous layer has in *in vitro* studies been associated with osteoblast activity, but not confirmed *in vivo* (27). The effect on implant fixation has been questioned.

- **Remodelling phase.** Bone remodelling reflects the functional adaptation of the bone structure and starts with

osteoclastic resorption. At the light microscopy level direct bone contact, osteogenesis and bone resorption occur simultaneously (60). Basic multicellular units (BMU) resorb woven bone and lay down new lamellar bone at the presented resorbed surface. Resorption and deposition are coupled in space and time. The resorption-formation frequency of the BMU is increased initially (44, 45). Osteogenic cells are derived from the endosteal trabecular surfaces and mesenchymal osteoprogenitor cells in marrow influenced by BMP release during resorption (34), while circulating mononuclear precursors supply osteoclasts.

Osseointegration is characterised by the direct connection between bone and implant surface. However, histologically, total bone contact does not occur. Levels of ingrowth into porous coatings vary considerably, ranging from 10-40% in intramedullary *in vivo* models (61-63) and 10-65% in clinically retrieved specimens (64-66).

This thesis evaluates the effect of adjuvant parathyroid hormone on the bone formation at an implant and in consequence implant fixation. The implant fixation is evaluated by both osseointegration and mechanical fixation. Given the studies are experimental, in this case, determination of osseointegration by light microscopy is feasible.

BONE GRAFT

Joint replacement can present with difficult bone defects. In the primary arthroplasty, loss of bone stock may be evident as arthritic cysts. In the revision setting, bone loss may be caused by osteolysis with cavitory defects, by peri-implant osteopenia or during implant change at the revision surgery. At revision initial implant fixation can be achieved on the femoral side by using a long stem. The stem may be uncemented passing the fixation from the proximal defective bone to the more distal viable bone, or it can be cemented as often used in older patients. On the acetabular side revision is often more challenging with the need of metal augmentations and highly trabecular or custom made cups with supplemental screw fixation. Changing a prosthetic component and the fixation method both intend to secure fixation, however bone grafting is often needed for supplemental implant stability. Impacting morsellised bone graft around the implant in these situations is a well-established method for optimizing the initial implant stability. Restoring bone with bone graft is therefore often used in younger patients or in patients with large defects.

History of bone graft

Bone grafting did not become an applicable and sustainable technique until the late 1970's. Hasting described in 1975 the use of bone graft for acetabular reconstruction of protrusio acetabuli (67). In 1984 Sloof introduced morsellised impacted bone grafting for cemented acetabular revisions (68). On the femoral side in 1985 the Exeter group introduced bone grafting without cement in which morsellised allograft was impacted around the stem (68). However, success was limited due to high subsidence and in 1987 the group introduced the cemented bone graft technique in which the stem-cement-graft-bone construction provides the initial fixation (69).

Present bone grafting

The effect of bone grafting on implant outcome and survival is hard to establish. In the revision setting an even larger number of factors influence the functional life of a prosthetic total joint compared to the primary arthroplasty. Clinically the evaluation may be by RSA on subsidence, by x-ray, patient evaluation scores and the need for re-revision. Grafted revised femur stems have been described with subsidence in 48% of the cases. In other series, ≥ 5 mm subsidence was seen in 20% of cases, and ≥ 10 mm in 4% (69). Admissible mid- and long-term results on the acetabular side show a survival rate of 94% at 11.8 years (70) but less on the femur side (71, 72). The outcome of a revision arthroplasty is considerably worse than after a primary arthroplasty. In Denmark, the 10-year survival for the first revision of total hip replacement is 80% and for second revisions 70% (9). Although both the cemented and uncemented grafting techniques are used to day, no definite reports are available on which technique provides best outcome (71).

Objective of bone grafting

The primary aim of bone grafting in total joint replacement is to give structural support of the prosthesis. Secondary, restoring bone loss is considered. In the ideal situation of bone grafting bone chips are impacted and fill the bone defects around the prosthesis with a secure fit of the implant. During remodelling, the graft must maintain its volume and shape, not only during the initial weight-bearing by the patient, but also during the entire remodelling period, which involves osteoclastic resorption of the graft and simultaneous osteoblastic cancellous new bone formation.

Graft biology

Bone graft material may be characterised according to *donor site*. Autograft is graft harvested from the same individual, allograft from another genetically different individual, and xenograft from a different species. Autograft is considered the golden standard, but sufficient amount is often hard to harvest and frequently involves donor site morbidity. Allograft has been used as a successful alternative. Immunogenicity may be reduced by modifications as freezing, drying, irradiation, rinsing, chemomodification (73).

Bone graft material can be characterised in *bone types by structure and histology* as cortical, cancellous, corticocancellous, or osteochondral. Cortical and corticocancellous struts have been used to reconstruct uncontained bone defects, while morsellised graft may impact more closed defects. Morsellised graft is most often applied.

Morsellised graft is a structure of bone fractures exposing the bone matrix to the surrounding tissues without a protective lining cell and osteoid layer. Bone graft material induces bone (*osteoiduction*) by releasing growth factors (BMP) during resorption and thereby stimulating local bone formation. Bone graft also performs as a scaffold for new bone formation (*osteoconduction*). The bone formation within mechanically stable grafts has been described as an intramembranous ossification (74, 75). The process by which graft is replaced with new bone over time has been described as creeping substitution (74).

Although bone graft is non-structural and particulate in nature, implant stability can be achieved with the impaction. After impaction the graft material recoils (76) and at the same time the mechanical loading causes graft interlocking movement (77). This adds to initial stability of the implant. Bigger size bone

chips increase stability of uncemented cups (78). The morsellised and impacted graft can still be regarded as a porous structure and ingrowth of vessels is thought not to be impaired (79). Even after a fairly firm experimental impaction, 35% of graft volume still consists of non-osseous material for the fibrovascular tissue to penetrate (80).

On the basis of radiographs that show increased radiographic density and load-oriented trabecular orientation, it is thought that most of the graft volume remodels into trabecular living bone (69). Histological studies in humans of biopsied or retrieved morsellised impacted grafts reveal mixed areas of remodelled bone and necrotic graft bone (81-87). Up to 4 years after grafting old bone is still visible (81, 83-85). Varying ingrowth of new bone into the bone graft has been shown. In a human retrieval study of grafted uncemented cups vascular penetration of 4 mm is seen at 18 and 53 months (83). Bone graft may remain encapsulated in fibrous tissue within the host bone many years after transplantation (87). Ingrowth into the morsellised impacted graft may be delayed or limited due to the impaction alone. Bone growth into a bone conduction chamber was reduced at 6 weeks, but not at 12 weeks compared to structural grafts (88). Bone graft size *per se* may not be an advantage in implant fixation. The relative area of surface per volume influences the degree of osteoconduction. However with the increased degrees of graft density impaction can in reverse reduce osteoconduction and this can be explained by the impacted graft acting as a hindrance for ingrowth of tissue (89). Mechanical load increases remodelling and new bone formation of morsellised impacted cancellous bone grafts. In the bone conduction chamber model both formation and resorption of the graft were increased (90).

PARATHYROID HORMONE

PTH and calcium homeostasis

Parathyroid hormone (PTH) is the hormone naturally secreted by the parathyroid gland. The genuine hormone is a chain of 84 amino acids (PTH(1-84)). It is the major regulator of bone metabolism and maintains homeostasis of the calcium ion in extracellular fluids within physiological limits (91). Secretion of PTH is controlled by serum calcium through negative feedback. PTH acts on bone, kidney, and gastrointestinal tract (91). In bone, calcium is liberated through a process of enhanced bone resorption by osteoclasts. The osteoclasts do not have PTH receptors and are indirectly activated by PTH. PTH activates the osteoblast PTHrP-receptor that stimulates its expression of RANKL. RANKL activates the RANK-receptor on the osteoclast precursors causing the cells to differentiate and resorb bone. In the kidney, PTH increases the active re-absorption of calcium from the distal tubules. In the intestine PTH enhances the absorption of calcium indirectly by activating the vitamin D precursor in the kidney, which then as activated 1.25-dihydroxy vitamin D exerts its calcium absorbing action in the intestine.

PTH shows dual action on bone (the PTH paradox) (92-95). The skeletal effect depends on administration:

- physiological: calcium homeostasis
- continuous: bone resorption (katabolic)
- intermittent: bone formation (anabolic)

History of PTH treatment

PTH improves skeletal mass when administered pulsative. The osteogenic potency of PTH has been known since the late

1920's. Based on work by Bauer from 1929, Selye (93) and Pugsley (96) demonstrated in 1932 that bovine extract of parathyroid injected daily for 30 days in rats caused macroscopically more dense bone than in untreated controls. They described large numbers of osteoblasts, which produced a massive marrow-obliteration of trabecular bone. Not until 1970 a pure PTH became available (97) and Kalu showed that the pure PTH(1-84) is osteosclerotic in thyro-parathyroidectomised (TPTX, calcitonin-free) rats (97). The year after in 1971 Potts introduced the hPTH(1-34) fragment which consists of the first 34 amino-acids of the genuine humane hormone (98). This fragment is fully active and became easy accessible in 1974 (99). In 1976 Reeve reported that hPTH(1-34) in elderly human individuals improved bone turnover and structural trabecular growth (100). Extensive investigation further ventured into the anabolic response on bone in human and experimental models of *remodelling bone*, either in normal or pathological bone (101, 102). This led to US FDA approval of hPTH(1-34) in 2002 and hPTH(1-84) in 2007 for treatment of patients who have osteoporosis and are at high risk of fracture.

Research on the effect of PTH on *regenerating bone* evolved in the late 1990's in experimental fracture studies, distraction osteogenesis and implant related studies. In 1999 Kim (103) was the first to demonstrate that a decrease in strength in fractures of ovariectomized rats could be prevented by hPTH(1-84). The same year Andreassen confirmed that hPTH(1-34) can enhance mechanical strength and callus volume in normal rats (104). The first human study on fracture healing has only recently been published by Aspenberg in 2010 showing moderate improved healing of non-operated distal radius fractures treated with hPTH(1-34) (105). The first implant related study saw the light of day in 2000 with the bone chamber studies by Skripitz (106, 107). This followed in 2001 when he demonstrated improved mechanical fixation by pull-out test of implanted stainless steel screws (108). No implant studies have been conducted in models of higher animal species in normal bone with implants of clinical nature.

PTH Fragment

The N-terminal part of the native hormone PTH(1-84) is associated with the anabolic properties of the hormone.

At equimolar doses the N-terminal fragments PTH(1-31), PTH(1-34), and PTH(1-38) have the same bone formative effect and pharmacological profiles as the native polypeptide PTH(1-84) (109-113). Fragments smaller than PTH(1-31) at the C-terminus lose their ability to stimulate bone growth. hPTH(1-30) does stimulate bone growth in ovariectomized rats, but larger doses are needed (114). Fragments shorter than this do not respond. Removing amino-acids at the N-terminus also eliminates the anabolic response, as demonstrated when transforming hPTH(1-38) into hPTH(3-38) and thereby eliminating the restoration of ovariectomy-induced bone loss in rats (115, 116). Although equipotency in bone formative parameters for PTH(1-34), PTH(1-31), and PTH(1-84) exist, differences in bone resorption may display being less in PTH(1-31) (93, 117).

Little information is available on the effect of heterolog PTH molecules in which PTH from one animal or human species is applied in another species. Little information is also available on the immunological responses to exogenous PTH. In clinical studies antibodies to hPTH(1-34) and hPTH(1-84) appear and are dose-dependent (102). Whether these antibodies bind in a manner to reduce biological activity is not known, or at least not apparent (102). The bone formative effect has most extensively been stud-

ied with the human PTH (hPTH) experimentally in various species and clinically. The bovine PTH (bPTH) is also effective (118). The human fragment PTH(1-34) has most often been used (101). However, increasing numbers of papers of the genuine human PTH(1-84) and other fragments are emerging.

In this thesis the human PTH(1-34) has been applied as adjuvant treatment for implant fixation.

PTH Pharmacokinetics

The osteogenic effect of PTH requires intermittent administration (119). This may be due to a situation in which the pulsative secretion pattern of PTH is mimicked. Administration is systemic by subcutaneous injections, although alternative administrations have been studied (120-122).

Depending on PTH dosage, a single subcutaneous injection of PTH leads to increase in PTH plasma concentration within 10-60 minutes with most of the PTH cleared from the circulation within 1 hour, and normalised serum levels within 4 hours (123-126). The duration of PTH in plasma above baseline influences the effect on bone. PTH infusion one hour/day in ovariectomized rats increases osteoblast number and bone formation, while longer infusion duration leads to focal bone resorption (119).

PTH dose regimens

The osteogenic effect of PTH depends on dose, administration frequency and duration of treatment (103, 106, 107, 127-129).

In the following, *remodelling bone* refers to intact, non-injured bone and *regenerating bone* to bone healing and repair as in fracture repair and implant osseointegration.

Dose

Tolerance and effective dosage of PTH vary among animal models. (130-134).

Bone remodelling in intact bone and bone healing in fracture models may deviate from the regenerate process of implant osseointegration. However, the effect of intermittent PTH on bone in these non-implanted bone models may prompt insight and potentials of PTH in the situation of implant osseointegration.

In models of *remodelling bone* with normal bone, aged, or osteoporotic bone doses commonly evaluated in *rats* are subcutaneous injections of PTH(1-34) and PTH(1-84) 60-200 µg/kg/day (106, 127, 129, 135-139). These dosages improve bone mass and biomechanical strength. Dose range studies show the highest dose inducing new bone with normal morphology is PTH(1-34) 200 µg/kg/day, while doses at 400 and 1000 µg/kg/day only induce small quantities of bone and this as endosteal woven bone (136, 140). Administering PTH (1-38) in a daily dosage of 1600 µg/kg/day is however catabolic (136). This follows the original work of Selye revealing bone resorption at high concentrations of parathyroid extract (93). Administering doses lower than 10 µg/kg/day in rats show conflicting results. (112, 140-142). In *rabbits* the effective dosage evaluated is PTH(1-34) 10-40 µg/kg/day (143). In higher animal species a similar dose related increase in bone formation is seen. In *monkeys* PTH(1-34) in dosage range 1-10 µg/kg/day (132, 144) or PTH(1-84) 5-25 µg/kg/day increases bone mineral density in spine and proximal tibia, and this primarily related to cancellous bone (145). In *canine* models of normal bone with PTH(1-34) in dosage range 0.375-6 µg/kg/day similar osteogenic findings apply in the proximal tibia, spine and iliac crest (146-150). In *humans* the optimal dosage for

Table 3

Model	Adm.	Rat	Rabbit	Monkey	Human
Fracture		15-150 (103, 151)	10-40 (153, 160)		20-40 (161)
	Daily	30 (152-155) 40 (156)			
		60-200 (104, 129, 157-159)			
	Weekly	10-30, x3 (162) 50, x5 (159) 100, x1 (138)		0.75-7.5 x2 (163)	
Implant	Daily	60 (108, 164-167) 15-240 (106, 155, 168)(154)			
		5-75, x5 (127) 6, x3 (164)			
	Weekly	25-30, x5 (169, 170) 30-60, x3 (108, 171-173) 40, x5 (174) 100, x1 (175)			
Distraction osteogenesis	Daily	5-25 (176, 177)			
	Weekly	60, x3.5 (139)			

Table 3. Summary of effective dose of PTH(1-34) administered systemically in models of bone repair. All dosages in animal studies are in unit $\mu\text{g}/\text{kg}/\text{day}$. Unit in human studies are $\mu\text{g}/\text{individual}/\text{day}$. "Adm." "Daily" indicates administration is daily, whereas the weekly administration is illustrated as number of injections per week. Studies in mice models are not included. No canine studies are available.

treatment of osteoporosis is PTH(1-34) 20 $\mu\text{g}/\text{day}$ per person (102). Although a dosage of 40 $\mu\text{g}/\text{day}$ has the same effect, this is less tolerated.

In models of *regenerating bone* (bone repair) a similar dose dependency exists. An overview of the evaluated doses is shown in the Appendix table 1 and a summary of the effective dosages is shown in table 3 in this section.

The dosage chosen for the studies in this thesis is 5 $\mu\text{g}/\text{day}$, which corresponds to the dosage used in studies in higher animal species.

Administration frequency

Although an anabolic response on bone demands a pulsative administration, daily injections are not necessary (table 3, Appendix table 2). In models of *remodelling bone* (normal bone or low-bone-density/osteoporotic bone) the anabolic response of PTH has been observed in monkeys, canines, rats and mice given 3-6 injections weekly. Parallel effect is seen in mice with weekly alternating injections, but not in canines with a weekly administration (146). In *regenerating bone* the effect is seen in models of fracture in monkeys and rats with injections 2-5 times weekly, in distraction osteogenesis injected every second day, and in implant models administered 3-5 times weekly. PTH seems to have less anabolic effect on bone when administration frequency is reduced, as shown in a rat study of remodelling bone with injections every second day compared to every third and fifth day (178).

Increasing administration frequency to more than once daily may induce bone resorption. In a canine model of remodelling bone with normal turnover multiple small daily doses of PTH resulted in an overall negative balance in trabecular bone (PTH USP Eli Lilly, 1.25 $\mu\text{g}/\text{kg}/\text{day}$, divided in 4 equal doses per day, 60 days)(118). However, the effect of multiple doses in rats may differ (154, 179). When the administration frequency of PTH becomes continuous, resorption is induced with loss of trabecular and cortical bone (95, 123-125).

The most commonly used administration is once daily. This frequency is used in the studies in this thesis.

Molecular and cellular mechanism of the anabolic PTH action

Intermittent administration of PTH stimulates bone formation. This is caused by increasing osteoblast number (180, 181) and activity (151, 155, 179, 182). The molecular and cellular mechanism underlying this effect is elucidated mainly by *in vitro* studies. However, increasing numbers of *in vivo* studies in remodelling and regenerating bone models are appearing.

Molecular mechanism

The anabolic response on bone of PTH is considered to be a cascade of signalling.

The action of PTH is mediated by the G protein coupled PTHR1 receptor (183). Binding of PTH to PTHR1 stimulates

- $\text{G}\alpha_s$ -mediated activation of adenylyl cyclase which stimulates cAMP production and subsequent activation of protein kinase (PKA)
- $\text{G}\alpha_q$ -mediated activation of protein kinase C (PKC)

Only PTH stimulated cAMP production seems sufficient for initiation of the signalling cascades that increase osteoblast number and bone anabolism. This is elucidated in the differential stimulation of $\text{G}\alpha_s$ and $\text{G}\alpha_q$ by various PTH fragments. Daily injections of PTH(1-34) and PTH(1-31) produce equivalent anabolic effects in rats. PTH(1-34) activates both cAMP and PKC production, while PTH(1-31) only activates cAMP (184). PTH(3-38) which activates PKC but not cAMP does not cause an anabolic response on bone (185).

PTH increases Runx2, which is a transcription factor associated with osteoblast differentiation (186). This is either by PTH a cAMP dependent down regulation of cyclin D1 or increase in synthesis of the cyclin-dependent kinase inhibitors p27KIP1 and p21Cip1 (187). Other markers related to osteoblast differentiation

are increased by intermittent PTH (alkaline phosphatase, procollagen type 1) (188).

Besides the direct activation of osteoblast differentiation and signalling, PTH also affects the synthesis of osteogenic growth factors and cytokines (188). PTH stimulates the synthesis of IGF-I, IGF-II, and FGF-2 via cAMP dependent mechanism. The action of sclerostin may be involved in the PTH response. Administration of PTH causes a transient reduction in the level of sclerostin mRNA (125, 188, 189). Osteocytes produce sclerostin, which inhibits osteoblast bone formation. PTH down-regulates the expression of sclerostin. This may increase osteoblastic bone formation. Wnt signalling contributes to the anabolic response by increasing survival of osteoblasts and differentiation of osteoblast progenitors (188, 190, 191).

Receptor kinetic studies contribute to the understanding of PTH action suggesting, that the PTH1R receptor is not desensitized by PTH but left sensitized for new cycles of activation (192).

Differences in bone cell genes are expressed when PTH is administered intermittent as to continuous. PTH treatment in rat bone regulates 22 genes including collagen and osteocalcin. Intermittent PTH regulates additional 19 genes. Continuous treatment involves additional 173 genes (188, 193). Continuous PTH increases gene expression of RANKL (RANK ligand), whereas that of osteoprotegerin (OPG) is decreased. Continuous PTH results in up to a 25 fold increase in the RANKL/OPG ratio with an increase in production of osteoclasts (194).

Cellular mechanism

Intermittent PTH treatment increases osteoblast number. The increased number has been proposed to be caused by a signalling cascade that 1) differentiates replicating osteoprogenitor cells into osteoblasts (recruitment), 2) postpones osteoblast apoptosis by survival signalling (survival), and 3) activates quiescent lining cells (re-activate) (187).

Recruitment of osteoblast cells by intermittent PTH treatment is suggested to be caused by the exit of osteoblast progenitors from the progenitor cell cycle (179, 187, 195).

Survival of osteoblast cells has been demonstrated in *in vitro* studies in which PTH activates survival signalling in the osteoblasts delaying their apoptosis(187). This has been confirmed in experimental studies in mice (196), but not in human (187, 197).

Re-activation of lining cells into active osteoblasts by intermittent PTH has been suggested (151, 155, 182) and shown in a rat model (179, 188). Daily injections of PTH increased osteoblast number in cancellous bone, but the percentage of 3H-thymidin labelled osteoblasts that developed from the labelled progenitors was not affected (179). It is thought that the increased osteoblast number is due to activation of pre-existing bone lining cells (179) Ultrastructural changes in lining cells with modulation into osteoblasts is seen with PTH administration (198). A week after withdrawal of PTH the cancellous bone surfaces are covered with lining cells without change in cell number, apparently by reversion of osteoblasts to lining cells. These findings may indicate, that the skeletal response to PTH (initially) is limited to existing cell number (179).

In *bone remodelling*, it has been suggested that the reactivation of the lining cells is the cause of the increased number of osteoblasts (151, 155, 182). However, *in regenerating bone* PTH has been associated with early increases in mesenchymal differentiation as well as proliferative effects on cartilage production. (154, 155, 180, 182, 199). In regenerating bone PTH increases osteoblast number, (138, 162, 180, 181), recruits osteoprogenitor

cells (92, 154, 199, 200) and chondroprogenitor cells (154). In a rat model, injections of PTH increased proliferation of mesenchymal progenitors, and the development of soft (cartilage) callus in the early stages of fracture repair (103, 154, 155). In a bone conduction chamber study in a rat model, PTH did not increase the bone ingrowth distance in the chamber, indicating PTH not being osteoinductive. However PTH increased bone formation in the chamber behind the formation frontier once it had been initiated. (106, 107, 201) Accelerated osteoblast maturation is seen as indicated by *Osx* (and *Runx2*) expression in callus and marrow derived mesenchymal stem cell (MSC) (202). Increased expression of *osterix* (*Osx*), a marker of osteoblastic cell commitment, in fracture callus has been shown following PTH treatment in a mouse model (202).

Although intermittent PTH stimulates osteoblast activity, concomitant increased osteoclast activity is suggested (107, 118, 142, 153-155, 199, 203, 204).

Anabolic response of PTH on bone structure

PTH shows an anabolic response in both bone repair and remodelling bone. Comprehensive research has been conducted in intact remodelling bone and to a less extent in fracture healing. Although bone remodelling in intact bone and bone healing in fracture models may deviate from the regenerate process of implant osseointegration, insight and potentials of adjuvant PTH treatment in implant integration may be prompted by the effect on bone of intermittent PTH in these models.

Models of *remodelling bone* (normal bone or pathological bone of low-bone density) have been studied most extensively. Describing bone mass in general, PTH treatment in ovariectomized (OVX) rodents prevents bone loss following OVX and reverses pre-existing bone loss induced by OVX (188). In primates PTH treatment results in a significant increase in bone mineral density (primarily in trabecular bone) (144, 205-207). Human fracture-prevention studies show increased BMD (more prevailing in the spine with less effect in the hip) (102).

Although PTH in remodelling bone on the whole stimulates bone formation in all bone envelopes, the effect is more prominent in the trabecular bone sites (111, 132, 135, 146, 199, 208, 209). In *trabecular bone* intermittent PTH increases bone volume, trabecular thickness, trabecular number (species variation), trabecular connectivity, and mechanical strength (135, 145, 188, 207, 210, 211). In *cortical bone* intermittent PTH increases bone volume, cortical thickness, periosteal diameter, endocortical diameter, porosity (near endocortical surface), and mechanical strength (188, 197, 210-212).

Differences in remodelling bone apply in the effect of PTH on trabecular and cortical bone among animal species (188). In rats the *trabeculae* increase by PTH is primarily in trabecular thickness and not in number. In mouse trabecular thickness, number, and connectivity is increased. In primates the effect is primarily in trabecular number and connectivity. In human the trabecular bone volume and connectivity is primarily increased with a shift from rod-like lamellar structures to more plate-like structures. In the *cortical* envelope thickness is in general improved. In humans an increase in cortical thickness and endosteal bone formation is seen, but the periosteal bone formation and increased bone diameter seen in lower animal species is in humans more controversial (188, 197, 210-212).

Studies on the anabolic effect of PTH on *regenerating bone* are sparser, but not less convincing (Appendix, table 1).

In general, in animal models PTH enhances *fracture healing* (138, 152, 158, 162) by improving the rates of callus formation, callus mineralization, bone remodelling and callus mechanical strength at an earlier time than in untreated controls. In closed animal fracture models intermittent PTH(1-34) have all shown a positive effect on both callus size and strength (104, 152, 155). However, in an open fracture model of normal bone density, PTH failed to increase the rate of union (159). Increased fracture strength and callus volume was seen in rats with a tibia fracture treated for 8 weeks with PTH(1-34) or PTH(1-31), even after withdrawal of treatment (157). In rat models of closed fractures with aged and moderately impaired bone-healing responses high doses of PTH still enhanced callus size and strength (129, 151, 213). In ovariectomized rats PTH improved fracture healing with external callus consisting of more dense trabeculae, woven bone and higher total bone volume (103). Although studies in lower animals suggest increased fracture healing by an increase in callus formation and size (104, 158), PTH accelerates fracture healing in larger animals by shrinking callus size, accelerated callus maturation and increasing callus mineralization (163).

The first human study on fracture healing has only recently been published by Aspenberg et al in 2010 on non-operated distal radius fractures treated with hPTH(1-34) (105). The study showed a moderate reduced fracture healing time. The time to complete cortical bridging in the PTH group was 7.4 weeks compared with 9.1 weeks in the control group.

The bone formation of PTH (1-34) has been evaluated by placing *bone conduction chambers* in endosteal bone of rat tibia (106) and rabbit mandible (214). Skripitz et al (106) found during treatment from week 2 to 6 a small and non-significant increase in ingrowth distances of bone into the chamber, a metaplastic (membranous) ossification process, and with time a fivefold increase in bone density within the bone chamber. In non-implanted remodelling bone in the same rats an increase in density was barely detectable.

Research on PTH treatment for *implant* fixation is mentioned in the following section of the introduction "PTH and total joint replacement" and Appendix, table 1.

Non-uniform response of PTH on bone sites

The anabolic response of PTH exhibits variations between *species* (130-133). In models of lower animals, PTH is a powerful bone anabolic agent. In humans and higher animals of clinical relevance the magnitude is less profound. (130, 134).

PTH exhibits variations in anabolic response on bone *interskeletally* between bone sites (108, 132, 144, 199, 206, 215-219). Clinical trials measuring bone mass have shown that the proximal femur appears to be less responsive to the anabolic actions of PTH than the lumbar spine. (216, 217). In the femoral neck of rats a strong anabolic effect has been described (220). Also differences *intraskelletally* occur within the bone envelopes of cancellous, endocortical, cortical, and periosteal bone (101, 104, 132, 148, 199, 209, 221-223). The effect of PTH appears to be greater in cancellous than cortical bone (101, 111, 132, 135, 146, 199, 208, 209).

The anabolic response of PTH appears to be more pronounced at sites of *bone regeneration* than at sites of normal remodelling (104, 106, 107). In a rat study of regenerating bone PTH (60 µg/kg/day) caused a five-fold increase in bone density in a bone conduction chamber, whereas the increase in density in remodelling bone in the same rat was barely detectable (107). In contrast Andreassen (104) found increased callus formation in a

rat fracture model with a high dose of PTH (200 µg/kg/day). This treatment not only affected callus formation but had a positive effect on bone mineral density at the contralateral side as well, although smaller.

The reason for the non-uniform anabolic response of PTH has been related to differences in marrow composition at the skeletal sites (red versus yellow marrow related to vascularity and baseline rate of bone turnover) and loading conditions (148, 187).

PTH and total joint replacement

The effect of implant integration with adjuvant PTH treatment has been investigated (Appendix, table 1). Research is experimental and based on the rat and rabbit model. The general findings are increased implant osseointegration and mechanical stability. Research is so far confined to situations of pathological low bone density (127, 168, 170, 171, 174) or of screw insertion transcortically (107, 108, 164-167, 169, 173, 224).

In ovariectomized animals rescue of bone loss before implantation is assumed with PTH (1-34) 30 µg/kg 3 times weekly when administered for 20 weeks before and 2,4 and 8 weeks after titanium screw insertion (171). Commencing administration of PTH (1-34) at the time of implantation reveal similar effect increasing mechanical pull out force, stiffness and toughness with 5, 25, 75 µg/kg/day for 8 weeks (127). Osseointegration and bone volume were increased with no difference between the highest doses (127). When inserting titanium rods in tibia bone of protein undernourished animals PTH (1-34) 40 µg/kg/day for 8 weeks improves osseointegration (174). 25µg/kg PTH(1-34) 5 times weekly rescued the peri-implant bone volume and mechanical function by augmenting trabecular thickness (169).

In normal bone an increase in pull-out strength and removal torque has been described 4 weeks after implant insertion with daily injection 60 µg/kg PTH (1-34) (167). With the same dose three times a week pull-out strength was increased at time point 2 and 4 weeks, and implant bone contact improved at 1, 2 and 4 weeks (108). Implants were threaded stainless screws located trans-cortically with a cortical and subcortical bone element contributing.

Cancellous osseointegration of an implant after administration of PTH (1-34) has not previously been studied in higher animal species in normal bone with implants of clinical nature.

2. AIM OF THESIS

Long-term survival of uncemented total joint replacements relies on secure and lasting fixation. This is achieved by osseointegration. Parathyroid hormone administered intermittently has an anabolic effect on bone.

This thesis presents three studies on the effect of implant fixation with parathyroid hormone as adjuvant therapy in joint replacements.

The specific aim was testing the hypotheses

- Parathyroid hormone increases early osseointegration and mechanical fixation of titanium alloy implants in two settings – press-fit and gap (Study I and II).
- Parathyroid hormone improves the bone graft incorporation process by increasing early osseointegration and mechanical fixation of titanium alloy implants with impacted morsellised bone allograft around the implants (Study III).

3. METHODOLOGICAL CONSIDERATIONS

STUDY DESIGN

This thesis evaluated the effect of adjuvant *parathyroid hormone (PTH)* therapy on the initial integration of *implants*.

An experimental implant model was used with implants inserted in canine cancellous bone and randomisation to treatment with PTH (1-34) or control. An unpaired design was required due to the systemic nature of PTH administration. Different implant models were used depending on which aspect of the implant fixation that was desired to study. Identical implant models in identical implantation sites were compared within each study. Asymmetric loading pattern among animals between the left and right extremity may have applied. The studies were conducted in one serie. The studies and implantation sites were considered independent. In order to minimize bias to treatment, the groups were blinded until mechanical and histological analysis was completed and analysed with the exception of the animal keeper who administered the treatment of PTH/control.

EXPERIMENTAL MODEL

Experimental animals

Animal model

When initiating new treatments for human joint replacements it is crucial that evaluation is done in a clinically relevant model (225). An animal model is advantageous since the individual elements in the process may be studied in a standardised setting with high reproducibility. However, clinically in patients, the bone healing capacity may vary depending on status of host bone, concurrent diseases, drugs, and consumption of alcohol / tobacco (226). This may influence interpretation and extrapolation of the experimental data.

In studies of PTH several different animals were used. The bone anabolic response of PTH exhibits varying magnitude depending on species, the bone sites, and bone envelopes tested (108, 130, 131, 144, 199, 215). Lower level animals like rats may be more advantageous because of low costs in large series and homogenous populations. However, their bones are smaller and they have sparse cancellous bone, which results in implants inserted in marrow or abutting cortical bone. Also bone differs in composition (e.g. collagen content), hierarchical levels of bone structure, and remodelling. A certain size of experimental animal and bone sites are needed in clinically related studies of orthopaedic implants in order to have sufficient sized specimens for histomorphometry and mechanical testing. The canine was chosen as animal model on various grounds. The canine bone quality is in many ways similar to and most closely resembles human bone (227, 228). Canine bone is abundant in cancellous bone in the meta- and epiphysis of the long bones. The implantation sites were easily accessible, which reduced the surgical tissue trauma and eased post-operative observation. Several bone-implant studies in this model are available at our institution (229).

The studies were done in healthy bone and with a healing capacity much larger than in humans. The remodelling rate in dogs is 2-3 timer higher than in humans (230). This allowed a relative short observation time. Choosing juvenile single sex (male) canines reduced inter-individual biological variation in bone structure.

Ethical considerations

The Animal Care and Use Committee of the Minneapolis Medical Research Foundation (MMRF), Minneapolis, Minnesota, USA approved the studies. The animals were purpose bred for research. Surgery and observation was done at the Animal Care Facilities of MMRF and Hennepin County Medical Centre, Minneapolis, Minnesota, USA. The site veterinary surgeon directed surgery and animal care. The regulations of the National Institute of Health, USA were followed.

Exclusion of animals

Two animals in the PTH group died on day 6 and 8 postoperatively. All other animals completed the observation period with no other complications.

Implant models

Implant device

Three different experimental implant models were used

1. Implants inserted press-fit into surrounding bone (study I, press-fit implant model, figure 1)
2. Implants inserted in a 1 mm empty gap (study II, gap implant model, figure 2)
3. Implants inserted in a 2.5 mm gap with morsellised bone allograft impacted around the implant (study III, grafted gap implant model, figure 3)

Implantation site

The models were designed to resemble the practice with total joint replacements in humans with the component in the cancellous bone. Therefore implants were inserted in the proximal humerus in metaphyseal bone or proximal tibia bone, which enabled evaluation of implant osseointegration in the cancellous bone envelope with no cortical envelope contributing to the implant incorporation.

Inserting the implants in press-fit (study I) followed clinical practice in which an implant is placed in an undersized implant bone-bed (figure 1). Although intimate bone contact and initial fixation of a clinical orthopaedic implant is intended by inserting in press-fit, gaps of various sizes often exist between the prosthetic component and the surrounding bone. In the experimental gap model (figure 2 and 3) the peri-implant gaps were standardized and reproduced by applying consistent surgical technique and implants. The size of the gap in study II and III was established in these experimental gap models from previous studies at our institution. In the unloaded model with an empty gap (study II) the gap must be 1 mm or more in order to be a critical defect with poor osseointegration at this observation time (229). In the unloaded model with morsellised impacted allograft in the gap (study III) 3 mm with 6 week observation time implies (231, 232). In the empty gap model (study II) with no initial implant fixation *per se*, a top-washer and footplate secured the implant stability and maintained the concentricity of the gap. The washer also prevented soft tissue from growing in from the outer surface. In the allografted gap model (study III) the washers additionally contained the graft material in the gap.

All models were limited by the lack of implant weight bearing during gait cycle. Also the implants were not communicating with joint fluid and thereby not exposed to joint fluid pressure (229). However, the implanted bone was load bearing. In the proximal tibia the medullary canal may extend relatively proximally. Post-operative x-rays secured placements of implants.

Figure 1



Figure 1. Study I. Press-fit implant model. Press-fit implant device, dimension 10x6 mm. Implant inserted in a 0.1 mm undersized bone bed in the left proximal tibia. X-ray image at time of bone harvest completing 4 weeks treatment of PTH/control.

Figure 2

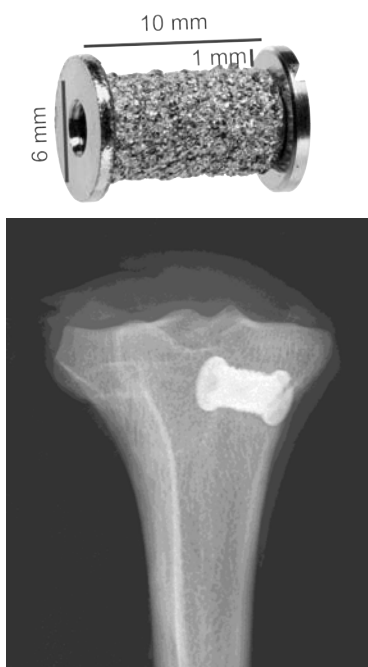

Figure 2. Study I. Gap implant model. Gap implant device, dimension 10x6 mm with end-washers of 8 mm securing a 1 mm circumferential empty gap. Implant in the right proximal tibia. X-ray image at time of bone harvest completing 4 weeks treatment of PTH/control.

Figure 3

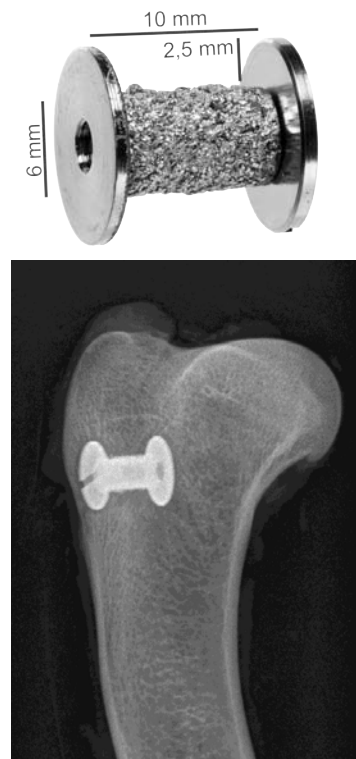

Figure 3. Study III. Allografted gap implant model. Gap implant device, dimension 10x6 mm surrounded by a 2.5 mm gap impacted with morsellised allograft bone secured by 11 mm washer. Implant in host of cancellous bone in the right proximal humerus. X-ray image at time of bone harvest completing 4 weeks treatment of PTH/control.

Implant characteristics

The cylindrical implant shape enabled standardization of surgical procedures and peri-implant gaps by cylindrical hole drilling. Also, mechanical analysis in push-out test is optimized. Vertical sectioning of the central portions of the implant is also possible, which is a prerequisite for unbiased stereological sampling.

Implants for all studies were custom made by the same manufacturer (Biomet Inc., Warsaw, IN, USA). Implants in a study were from the same batch. All implants were cylindrical porous coated with a nominal length of 10 mm and an outer diameter of 6 mm (table 4). Endcaps were attached in study II with a diameter of 8 mm and in study III of 11 mm.

Table 4

	Study I: Press-fit	Study II: Gap	Study III: Graft
Implant diameter	6.13 (0.14)	6.20 (0.06)	5.95 (0.09)
Implant length	10.24 (0.19)	10.91 (0.12) ¹⁾	10.94 (0.04) ¹⁾
Endcap diameter	n/a	8.00 (0.02)	11.06 (0.02)

Table 4. Dimension of implant. Data presented as mean (SD), ¹⁾ Length with one endcap mounted on implant (footplate), n/a = not available.

Variation in diameter may be due to implant sphericity / roundness and isolated spikes in implant porosity.

The implant core consisted of titanium alloy (Ti6Al4V) with a plasma-sprayed porous coating of titanium alloy (Ti6Al4V) super-

imposed (figure 1-3). The implant material and porous coating was similar to the manufacturers clinically available implants. Within a study implants were randomised to animals.

Four additional implants in each study were randomly chosen among the implants intended for implantation. The surface roughness was evaluated with quantitative topography (The Danish Technological Institute, Copenhagen, Denmark) (Roughness profilometer, Somicronic Surfscan, 3CS, Hommel Somicronic, France) (table 5). Rotating the implant 45 degrees, eight measurements per implant were performed.

Table 5

	Study I: Press-fit	Study II: Gap	Study III: Graft
Ra	55.6 (51.1-63.5)	66.1 (60.7-72.8)	66.3 (62.6-70.9)
Rz	267.0 (237.6-299.3)	307.1 (290.4-323.3)	322.5 (311.8-336.4)
Rq	67.3 (60.7-76.5)	79.0 (72.8-85.5)	80.0 (76.3-85.1)
Rmax	267.0 (237.6-299.3)	307.1 (290.4-323.3)	322.5 (311.8-336.4)

Table 5. Surface topography. Data presented as mean (range). Ra(μm) = "average surface roughness" / arithmetic average of the deviation from the mean line over a sampling length, Rz(μm) = average height difference between the five highest peaks and the five lowest valleys, Rq(μm) = root mean square value of the profile departure, and Rmax(μm) = maximum peak-to-valley height.

Parathyroid hormone

Hormone preparation

PTH and drug vehicle was prepared in a sterile environment according to Andreassen (104) using a vehicle of heat inactivated 2 % canine serum (560 C, 1h) (S-1757, Sigma-Aldrich, Saint Louis, USA) in 0.9% NaCl (NaCl, Baxter Healthcare Corp., Deerfield USA) adjusted to pH 5 (Hydrochloric Acid 1.0 N, Mallinckrodt Chemicals, Mallinckrodt Paris, USA). Before adding PTH the vehicle solution was sterilised with a 0.22 μm micropore sterilizations filter (Nalgene Filtration 0.2, Nalge Nunc International / Apogent Technologies, Rochester, USA) (233, 234). The drugs for the whole study were prepared all at once and stored at -20°C until use.

Hormone administration

Postoperatively, the animals were randomly divided in two groups of ten. The intervention group was injected with human PTH(1-34) (Bachem Holding, Bubendorf, Switzerland)) subcutaneously 5 $\mu\text{g}/\text{kg}$ body weight daily (with the exception of one day) between 8 am and 10 am starting on the day after surgery and continued until completing the 4-week observation period. The animals were weighed once a week, and the doses were adjusted to body weight in 0.5 kg increments. The control group was injected with drug vehicle in similar volume. On day 11 PTH(1-34) was changed from research grade to GMP grade (Bachem, Torrance, CA, USA) with unaltered dosage. This change was made due to concern on Tri-Fluoroacetic Acid (TFA) content.

Bone allograft

In study III the gap was impacted with bone allograft. Cancellous allograft bone was harvested under sterile conditions from the humeral heads of canines not included in the study. Preparation of graft for the whole study was done two days before implant surgery. Using a bone mill (L160, 3M, St. Paul, MN), bone

from donors was milled once and mixed before being divided into portions of 2 ml. The bone was kept frozen at -20°C . At surgery the bone graft was thawed for one hour prior to use and inserted into the peri-implant gap with custom-made impaction tools. Using the finest grater in the bone mill, the graft was milled to chips, which could be used in a 2.5 mm gap. These chips were smaller than typical in the clinical settings and it is noted that smaller chips incorporate and resorb faster (235). The amount of allograft in the peri-implant gap was evaluated by weight with mean (SD) 1.99 (0.15) g with no significant differences between PTH treatment group and control. A top washer kept graft in place and centralized the implant. All pre- and peroperative handling of the allograft was done by the same person (HD) in order to standardize impaction

Surgery and postoperative period

Surgery was performed under sterile conditions and under general anaesthesia monitored by the site veterinary surgeon. In order to control reproducibility of implantation at surgery the same surgeon handled all implants in a study, implants were inserted in a standardized surgical procedure with fixed landmarks and postoperative x-ray confirmed correct implant positioning. All studies were performed in the same surgery session.

Surgical technique

Implantation sites were exposed. A K-wire was used to establish the point for implant insertion and to guide the cannulated drill while creating the drill hole. In order to avoid thermal trauma to the bone drilling was at low speed (< 2 HZ) and cooled with saline irrigation drip. The overlying fascia and skin was closed in layers.

Study I: Press-fit. The anteromedial surface of the proximal tibia was exposed by a medial incision. The cranial tibia muscle and medial collateral ligament were spared and the periosteum elevated in implant insertion area. A 2.5 mm guide wire was inserted into the proximal tibia metaphyseal bone 12 mm from the femurotibial joint line, perpendicular to the anterior medial bone surface. Over the guide wire, a cannulated 5.9 mm drill was used to drill the cylindrical bone bed cavity. Immediately after drilling the implant was inserted.

Study II: Gap. The surgical access was identical as in study I. An 8.0 mm cannulated drill prepared the cylindrical bone cavity. Immediately after drilling, the implant with footplate was inserted. The top washer was then mounted in situ, securing the construct to the bone.

Study III: Graft. The incision was made on the lateral proximal humerus from the top edge of the greater tubercle. Blunt dissection under the deltoid muscle exposed the periosteum. A 2.5 mm Kirschner-guide-wire was inserted anterolateral and perpendicular to the surface at a distance of 1.7 mm from the top of the major tubercle. The implant bed was drilled with a cannulated 11 mm drill. The implant with the footplate was inserted and premeasured bone graft was impacted. Finally, a top washer was mounted onto the implant to contain the graft.

Postoperative observation

The dogs were housed individually and socialised daily in groups. Animals were allowed unrestricted weight bearing. The veterinary surgeon inspected the canines daily as to wound healing, weight-bearing, diet and general condition. All animals were fully weight bearing the day after surgery.

Observation time.

A long lasting joint replacement depends on early osseointegration. In order to determine a potential optimization of the early implant fixation a 4-week observation period was chosen. A short period might not have given enough time to exert an effect. A longer period might have depleted the effect in that the control implant could have reached the same implant fixation as the intervention. Also, a long period might exceed the clinical relevance of early osseointegration. PTH *per se* shows species dependency in potency and therefore effect-related in time. Previous studies in the applied canine implant models have shown that stimulation factors with a 4 week observation period is sufficient to improve osseointegration and implant fixation (229, 231).

Specimen block preparation

No clinical signs of infection at the implant sites were observed at bone harvest. Joint fluid was obtained at euthanasia and cultured to rule out infection. A block of bone containing implants and surrounding bone was cut from the proximal tibia (study I, II) and proximal humerus (study III), and bone specimens frozen at -20°C until sectioning. All specimen preparation was done blinded as to treatment group and by the same person in a study. Two transverse bone-implant specimens were obtained using a water-cooled diamond band saw and implant based alignment post (Exact Apperatebau, Nordstedt, Germany) (figure 4).

Figure 4

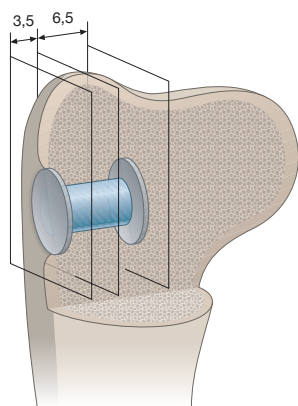

Figure 4. Sectioning technique. Specimen from study III illustrating sectioning technique. Implant in-situ in right humerus metaphyseal bone.

The first and most superficial specimen with a thickness of 3.5 mm was used for mechanical testing and stored at -20°C until testing (figure 5). The inner 6.5 mm implant section was fixed in alcohol 70% and processed for un-decalcified histomorphometric evaluation with implant-in-situ. Hence, all specimens for mechanical testing and histomorphometry were taken consistently from the same part of the implant. This eliminated bias in potential anatomical difference in peri-implant bone quality along the implant length in specimens from alternating implant ends.

Figure 5

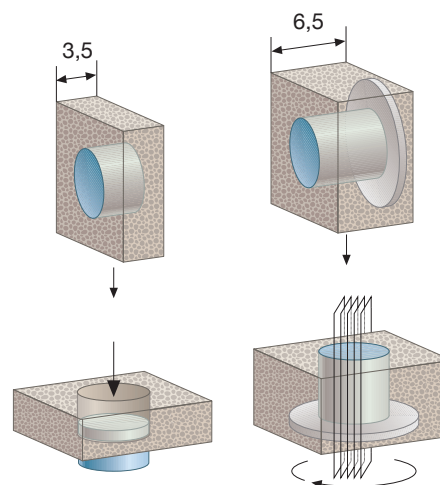

Figure 5. Sectioning technique illustrated with specimen from study III. Left image: outer section specimen (3.5 mm) for mechanical testing. Right image: Inner section specimen (6.5 mm) for histomorphometry using the vertical section method applying 4 sections around implant centre after random rotation around implant axis.

Sample size

The number of animals included was based on a sample size estimation for the unpaired study groups using the equation (236):

$$n_1 = n_2 \geq \frac{2(z_{1-\alpha/2} + z_{1-\beta})^2 SD^2}{d^2}$$

Abbreviations are:

n_1 and n_2 is the number of individuals in each treatment group, $z_{1-\alpha/2}$ is the $(1-\alpha/2)$ quantile and $z_{1-\beta}$ is the $(1-\beta)$ quantile in the standard normal distribution at two-sided testing. SD is the estimated standard deviation on group differences assumed to be similar in both groups; d is the minimal relative difference to be detected.

The assumptions for sample size estimations were based on mechanical and histomorphometric data from previous studies using similar models at our institution. The risk of type I error (α) was set to 0.05, and the risk of type II error (β) was set to 0.2. The standard deviation (SD) was 50% and the minimal relevant difference (d) was set to 80%.

Sample size was calculated to 16 and 20 animals were included in the studies.

HISTOMORPHOMETRIC ANALYSIS

The implant osseointegration was evaluated by histomorphometry applying stereological methods in the sampling of sections and of tissue parameters.

Histological specimen preparation

Staining

The specimens for histomorphometry were dehydrated in graded ethanol (70-100 %) containing 0.4 % basic fuchsin (Merck, Darmstadt, Germany) followed by embedding in methylmethacrylate (MMA, Merck, Hohenbruun, Germany). After specimen sectioning, the surface was counter-stained with 2 % light green (Light Green SF, BDH Laboratory Supplies, Poole, England) for 2 minutes. The staining technique made it possible to distin-

guish bone at the section surface (green), and fibrous tissue / bone marrow tissue (red) (237).

The penetration depth of the light green stain was determined to be in the range of 3-10 μm . This was evaluated on additional sections in study I with sections perpendicular to the stained surface of the specimen block in the peri-implant bone, which was not subjected to implantation. This is consistent with a previous study at our laboratory (238).

Sectioning

Four vertical uniform random sections were cut with a hard-tissue microtome (KDG-95, MeProTech, Heerhugoward, Netherland) (figure 5). Specimen blocks were random rotated around the implant long axis in order to randomly establish the plane for sectioning. The sections were cut serially at the centre part of the implant, parallel to implant long axis, and 400 μm apart as the space minimal achieved due to kerf of the saw.

The specimen thickness was determined to be mean (SD) 32.3 (7.0) μm (study I) and 40.8 (7.1) μm (study II).

Implant length for histomorphometric analysis (study II) was determined to be mean (SD) 5802 (503) μm

Histomorphometric set up

Histomorphometric analysis was performed with light microscope (Olympus BX50 (study I-III), Olympus BX51TF (study II)). The field of vision in the microscope image was transmitted to a computer monitor. A computer assisted stereologic image analysis application superimposed test probes on the image, and conducted the sampling of the tissue parameters (CAST-Grid, CAST Version 2.1.4, Olympus Denmark (study I-II) and newCAST, VIS Version 2.16.1.0, Visiopharm Integrator System, Denmark (study III)).

In all studies the implant was oriented and aligned on the microscope stage in the same way. The non-sectioned end of the implant was placed so the end was at the top of the computer screen, which in study II-III was the end with the washer mounted.

Definition of region of interest (ROI) was done with objective x1.25, which with the microscope adapters, camera and computer screen gave a total of magnification of x35 (study I), x54 (study II), and x30 (study III). In study I-II a template overlay on the computer screen was used to outline the regions. In study III the software enabled outlining of regions with integrated measurement lines. Parameter sampling was done at objective x10 (study I-II) and x20 (study III) with a total magnification of x282 (study I), x431 (study II) and x499 (study III). Calibration of Lens and Par-Centre-Lens was done at the initiation of a study and the stage orientation was secured daily.

Parameters were sampled by meander, which included systemic sampling of the regions with random choice of the first screen-field within the region. Line probes for surface fraction sampling were sine weighed and random rotated, while volume fraction sampling was with point grid counting (figure 6). Test system was calibrated with minimum 100 tissue line interceptions and points per region as recommended (239). The whole implant surface and peri-implant tissue within region was sampled. Parameter sampling was done blinded and by the same person. All regions were counted in the same session and independent.

Histomorphometry

The osseointegration of an implant was evaluated as bone-in-contact with implant (tissue surface fraction) and peri-implant

bone volume (tissue volume fraction). Tissue at implant interface and peri-implant bone was estimated in concentric zones of relevance as to the implant model (figure 6+7+8).

Figure 6

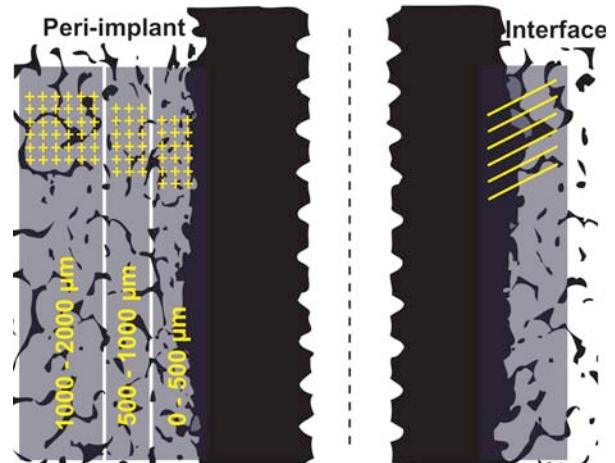

Figure 6. Study I. Press-fit Histomorphometry. Schematic drawing. Region of interest (ROI) collectively defined on both implant sides, but illustrated on one side above: a) interface (illustrated on right image) and b) peri-implant 0-500 μm , 500-1000 μm , and 1000-2000 μm (illustrated on left image). Interface tissue counting (surface fraction) was done with sine-weighted line probe (right illustration) and peri-implant tissue counting (tissue volume fraction) with point probe grid (left illustration). Regions defined from the mean implant surface and 500 μm below the cleared (non-sectioned) end of implant.

Figure 7

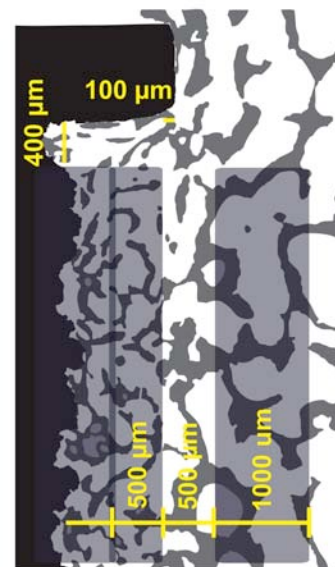

Figure 7. Study II. Gap. Histomorphometry. Schematic drawing. Region of interest (ROI) collectively defined on both implant sides, but illustrated on one side above: a) tissue ongrowth (surface fraction) at interface, b) tissue volume fraction in gap divided in two of an inner gap region and an outer gap region (500 μm), and c) tissue volume fraction in region of intact non-implanted bone (1000 μm). Regions defined from washer margin as a fixed point with a 100 μm clearance at gap-intact-bone-interface and 400 μm below washer.

Figure 8

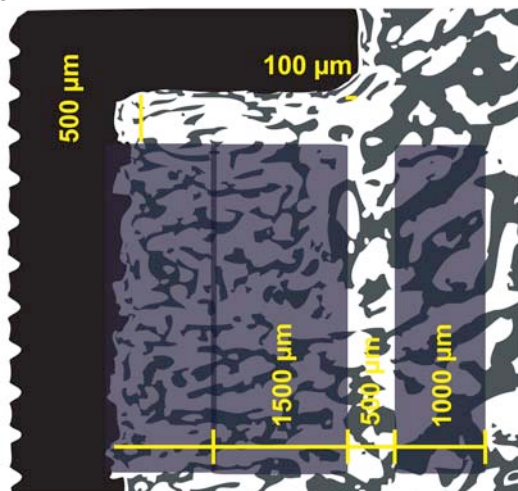

Figure 8. Study III. Graft. Histomorphometry. Schematic drawing. Region of interest (ROI) collectively defined on both implant sides, but illustrated on one side above: a) Tissue ongrowth (surface fraction) at implant surface, b) tissue volume fraction in grafted gap of 2.5 mm divided in two of an outer region (1500 µm) and an inner region reaching implant surface, c) tissue volume fraction in region of intact non-implanted bone (1000 µm). Regions defined from end-washer margin as a fixed point with a 100 µm clearance at gap-intact-bone-interface and 500 µm below washer.

Tissue definition

Histomorphometry was based on the tissue morphology. Sampling was done with light and polarized microscopy.

Bone at the cut surface stained green. Overall, bone was discriminated as woven bone, lamellar bone and allograft. *Woven bone* was randomly organised in structure, in the cells and in the fibrous organisation of bone matrix. Osteocytes were larger, spherical and more widespread. *Lamellar bone* was organised more homogeneously and was arranged as lamellae in parallel structures ("plywood" structure) with osteocytes being bipolar and appearing flattened on a line. *Allograft* was in structure trabecular lamellar with empty lacunae and colourfastness. When difficulties arose in discrimination between woven and lamellar bone, polarized light was used in order to illuminate the inherent differences in collagen fibre organisation. Fluorescence microscopy assisted the distinction of allograft.

Fibrous tissue and bone marrow stained red. Fibrous tissue appeared as parallel fibres and low cell density. *Bone marrow tissue* showed cellular masses of blood / marrow cells lying between round empty fat vacuoles.

Exclusions histomorphometric analysis

Study I: One implant specimen in the control group was excluded before testing due to mix-up of implant devices during surgery. Study II-III: No implant specimens were excluded.

Bias

This thesis evaluated the osseointegration of an implant on the tissue parameters at the implant surface (tissue surface fractions) and in peri-implant bone (tissue volume fractions). These 3-D concentric areas around the implant represented the reference space for evaluation. From this space four vertical uniform sections for histology was applied, regions of interest (ROI) were defined and parameters sampled. These 2-D *histological sections* were fractions of the 3-D reference space and therefore need to be representative and equally unbiased sampled (uniform and

random). From the 2-D histological sections *estimates* were made of tissue parameters present in 3-D and these estimates similarly needs equally unbiased sampling. Bias may have involved the sampling process reaching from histological sectioning to final estimates of tissue parameters.

Stereological bias

Trabecular bone is anisotropic, which means that the bone morphology is oriented (240, 241). A surface of an implant is also assumed to be anisotropic. An unbiased sampling of histological sections and of tissue parameters needs to take this into account in the sectioning technique and in the probe chosen for parameter sampling. The sampled tissue volume in the peri-implant bone was a 3-D structure, while the tissue at the implant surface was an area of 2-D. Stereological bias may be introduced if dimensions-in-space of the probe are insufficient as to dimension-in-space of the tissue parameters. Basic stereological principles for unbiased sampling state that the sum of dimensions in the probe and the parameter must equal at least 3. That is, the number of dimensions in the tissue, which *per se* is 3-D, must not exceed the sum of dimensions in the parameter sampled and the sampling probe. This relates to equal probability of sampling. The probes must be distributed uniform random and either the probe or the tissue must be isotropic. Therefore, with stereological applications tissue volume fractions (3-D) can be estimated with dimensionless point probes (0-D) and do not require isotropy of the tissue estimated. Surface fractions (2-D) can be estimated by one-dimension line probes (1-D) and as result require isotropy. In order to obtain unbiased estimates of tissue parameters on the implant surface either isotropic uniform sections or isotropic random test probes on vertical sections apply (242, 243).

In all studies stereological sectioning and parameter sampling was used (239, 242). The vertical sectioning technique was applied with the long axis of the implant defining the vertical axis for uniform random rotation. Rotating the cylindrical embedded specimen block randomly defined the offset for the first section (figure 5). Subsequent sections were done parallel and serial by systematic uniform random section sampling. Sampling of four serial sections of the central portion of the implant allowed three-dimensionally structured tissue to be quantified.

Estimation of tissue parameters at the implant surface (surface fraction) was done with sine-weighted line probes and peri-implant tissue counting (tissue volume fraction) with point grid probe (figure 6). The applied stereological methods in sectioning and sampling have been shown to provide reliable estimates with minimal bias (239, 244).

Tissue close to the implant surface may have been overrepresented due to central section bias (244). Point probes far from the implant vertical axis (surface) may have represented larger volumes than in the reverse, which implies that a structure far from surface was selected with less probability. This bias inherent in the used implant model and sectioning technique has been shown to be minimal (244).

Selecting sections

Sampling was done from four sections. Previous studies have shown, that four sections as to 14 sufficed with limited effect on variance (239). The first section was defined randomly and serial sections were done with the space being the minimal achievable (239). Applying sections with minimal achievable distance may have introduced bias as to sections being representative. If bone were homogeneous one section would have been sufficient.

Applying four sections of approximately 35 μm thickness and 400 μm apart covered approximately 1300 μm of the centre region. However, by enlarging the sampling coverage in the specimen block with further distance between sections may have introduced bias in ROI definition and is therefore not applied.

ROI definition

The applied implant model was a cylindrical implant inserted in bone in a cylindrical hole in press-fit (study I) or in a gap (study II and III). A section for histomorphometry at the centre of the implant represented the concentric peri-implant reference space. A section away from the centre at the periphery of the implant presented an oblique section as to the implant cylinder radius (figure 9+10). In sections of extreme close to the implant periphery, the peri-implant region appeared widened and ROI deviates from the reference space.

Figure 9

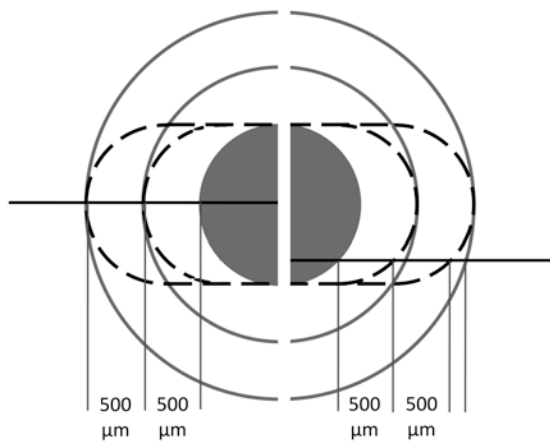

Figure 9. Section offset and ROI definition. Study I. Schematic drawing of a transverse section of the implant. Left image: section at the implant centre, right image section at the periphery of the implant. Gray circle illustrates the implant. The circle lines outline the circumferential region 0-500 μm and 500-1000 μm around the implant. Region of interest defined from the mean implant surface. Dotted line indicates the region of interest with the section deviant from centre section.

Figure 10

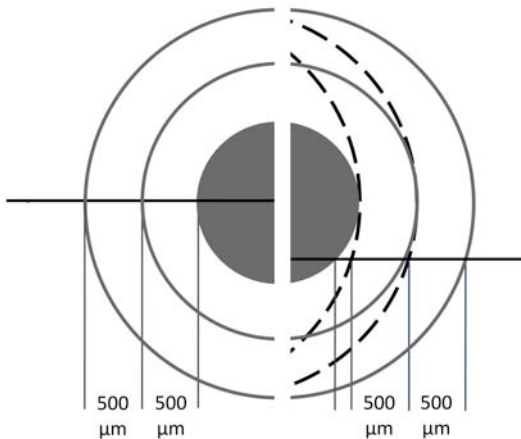

Figure 10. Section offset and ROI definition. Study II. Schematic drawing of a transverse section of the implant. Left image: section at the implant centre, right image section at the periphery of the implant. Gray circle illustrates the implant. The endcap is not shown but corresponds to the outer circle line. Implant gap in this image is divided in two of circumferential region 0-500 μm and 500-1000 μm around the implant. Region of interest defined from the endcap. Dotted line indicates the region of interest with the section deviant from centre section.

In all studies regions were defined with the implant as the point of origin. The washer margin was considered an easy line to define with high reproducibility. In study II and III the end-washer margin was the fix point for defining regions. From the washer-line the regions were outlined starting at the washer margin expanding in towards implant surface. The zones were of a defined width, were in specified zones, and with the last zone reaching the implant surface. In a section at the implant periphery the ROI was however expanded predominantly in the inner zone (figure 10). In study I there was not a washer and regions were outlined from an arbitrary line defining the mean implant surface. All zones were of a fixed width expanding outwards from the implant surface. Increasing the distance between the implant centre and the section decreased the fraction of reference covered by ROI on the histological sample, and this predominantly in the outer zone (figure 9). The sampled region (ROI) did not cover the entire reference space. The part not covered was the most peripheral zone and the sampled regions may have represented samples from neighbouring regions. Under the assumption of an implant diameter of 6 mm, a *maximum* section offset from implant centre of 1.3 mm and a reference space of 1000 μm the *minimum coverage* on the section was 93 %. In all studies the sections were done on the same microtome and by the same laboratory technician securing centered implant sections.

Tissue differentiation and staining

Tissue parameters were sampled at the implant interface as tissue in direct contact with implant surface at light microscopy, and in the peri-implant bone.

In study I, bone was discriminated as woven and lamellar bone, and woven bone was assumed being the bone formed in the observation period of the studies. New bone formation as lamellar bone was not estimated. This may have introduced bias in evaluating the new bone formation with the applied adjuvant treatment. In study III fluorescence aid and magnification modified the bone differentiation with parameters of new bone and old bone (allograft) in the gap.

Light green stained mineralised bone green. Osteoid was not stained. This may have caused bias in new bone (study I-III).

As seen in the results, the adjuvant PTH therapy may have benefited from biases of new bone formation being underestimated.

Section thickness

Histological sections need to be thin to reveal osseointegration as bone in contact with the implant on the light microscopy level. In sections of implant-bone specimens the implant limited the minimum thickness of the section. Specimen preparation with mechanical removal of the implant after embedding has been used. However, this technique imposes bias in the estimates of tissue at the implant surface as tissue at the surface may be removed with the implant. Histological sections in all studies were processed as undecalcified sections with implant in situ in bone securing estimates of tissue visually in direct contact with the implant. The average thickness estimated was 32-41 μm (study I-II).

Thicker sections may have had a shadow effect. This is caused when an object is cut oblique to the object surface. In a cylindrical implant this holds true with sections cut parallel to the long axis at the periphery of the cylinder. This may impair the resolution at the implant surface making it difficult to state

whether or not true direct bone contact has been achieved. Increasing both section thickness and section offset from implant centre increases the shadow effect. In the applied implant model the bias on the parameters of tissue in contact with implant surface was small with sections at the implant centre. Assuming an implant diameter of 6 mm, a section thickness of 30 micron, and that the sections were cut with a maximum offset of 1.5 mm from the implant centre, then the maximum shadow effect could be calculated to be 17 micron. An osteoclast is around 50-100 micron. So, as long as the section sampling coverage was within 1.5 mm from the implant centre the shadow effect is acceptable.

Thicker sections may have caused tissue over-projection. In thick sections tissue less transparent (i.e. more visible)(bone) may have been oversampled. In all studies light green was used to counter stain bone at the cutting surface, while bone deeper in the section remained unaffected. The penetration depth of light green was low. In the applied implant model the plane used for sampling in the section was defined as only the most superficial morphological focus plane in which also light green stained the superficial bone tissue. This provided a reliable plane for focus and sampling in the light microscope and minimized the bias of over-projection.

Reproducibility of histomorphometry

The histomorphometric reproducibility was estimated from double measurements by the same person (intra-observer variation) using the identical equipment and setup (table 6-8). Four implant specimens with two from each treatment group were randomly selected and sampled at a monthly interval. Reproducibility was expressed as coefficient of variance of tissue surface estimates at implant interface and tissue volume estimates in peri-implant regions:

$$CV = \frac{\sqrt{\frac{1}{2}k \sum_1^k d^2}}{\bar{x}}$$

Abbreviations are:

CV = coefficient of variation, k = number of double estimates, d = difference between first and second double estimate, \bar{x} = value of first and second estimate.

Table 6

	Bone	Marrow	Fibrous
Interface	13	2	0
Region 0-500 μ m	9	2	0
Region 500-1000 μ m	8	2	0
Region 1000-2000 μ m	9	2	0

Table 6. Reproducibility, Press-fit model (study I), CV in percent

Table 7

	Bone	Marrow	Fibrous
Interface	7	5	13
Inner gap	6	3	15
Outer gap	2	1	0
Intact bone	7	3	0

Table 7. Reproducibility, Gap model (empty gap) (study II), CV in percent

Table 8

	Total bone	New bone	Old bone	Marrow	Fibrous
Interface	4	8	3	7	0
Inner gap	1	3	4	1	0
Outer gap	1	4	3	0	0

Table 8. Reproducibility, Gap model (grafted gap) (study II), CV in percent

A test sampling was done at the initiation of each study in order to minimize bias from the learning curve of tissue identification and sampling.

MECHANICAL TESTING

Mechanical testing set-up

The mechanical implant fixation was evaluated by axial push-out test to failure (MTS 858 Mini Bionix, MTS System Corporation, Eden Prairie, MN, US) (Software MTS Test Star 790.00 Version 4.00). Testing of all specimens was done in one session and blinded as to treatment group. Specimens in each study were tested one hour after thawing. The specimens were placed on a metal support jig and the implant centred over a 7.4 mm circular opening assuring a 0.7 mm distance between the implant and support jig (figure 11). The piston diameter was 5.25 mm and a preload of 2 N with a 5 second hold was applied. Implants were pushed from the external side towards the inside of the bone. With a displacement velocity of 5 mm/min and a 10 kN load cell, continuous load (N) - displacement (mm) data were recorded.

Figure 11

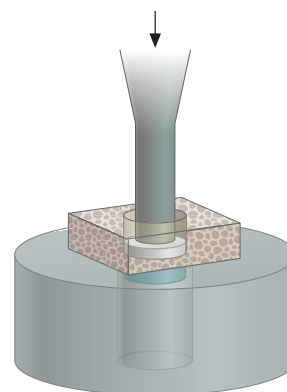

Figure 11. Mechanical testing. Axial push out test with specimen placed on metal platform with central opening. Specimen thickness nominal 3.5 mm, implant nominal diameter 6 mm, support hole diameter 7.4 mm, preload 2N, displacement velocity 5 mm/min.

Mechanical fixation was evaluated from the normalised data as the mechanical parameters (figure 12)

- maximum shear strength
- maximum shear stiffness
- total energy absorption

Figure 12

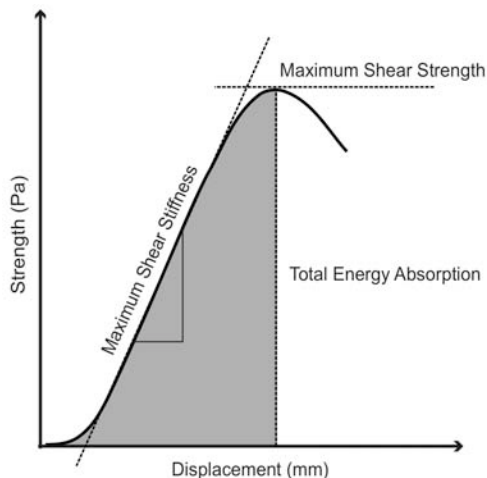

Figure 12. Mechanical testing. Normalisation of load-displacement curve enables calculation of maximum shear strength (MPa), maximum shear stiffness (MPa/mm), total energy absorption (J/m²).

Mechanical test type

The mechanical fixation was tested by a destructive push-out test to failure. During weight bearing a prosthesis is exposed to combined shearing, compressive and bending forces. The ideal test for evaluating the mechanical fixation in this situation does not exist. When testing the bone-implant interface different values of the mechanical parameters are obtained depending on the specific test and the test conditions. Also, the implant model may restrict the usefulness of a test. A torsion test of cylindrical implants generates values different from a push-out-test in mainly shear (245). The applied push-out test reflected the bone surrounding the implant and at the interface, and the dynamic micro interlocking of bone along the porous implant surface during testing. The mechanical parameters reflected consequently not only shear forces at implant interface, but also multiaxial tensile and compressive forces of bone interdigiting with the implant and surrounding tissue (246). A push-out test imitates more closely the stress applied to prosthesis. If the experimental conditions are well controlled the axial push-out test seems valid (245, 247).

Test conditions and bias

Bone is in general an anisotropic material (240, 241), depending on bone site (248-251). This means that mechanical properties depend on the loading direction and reflects its function as a load-bearing structure. All implants were tested along the long axis of the implant. An implant based alignment post ensured that specimens prepared for testing were cut perpendicular to the long axis. Oblique specimen cuts as to the implant axis may have resulted in overestimation of mechanical implant fixation due to multiaxial stress states around the implant, due to relative larger implant surface, and due to supportive bone under the implant axis. However, this potential bias was eliminated by random distribution between treatment groups. In a push-out test the mechanical data depend on the test direction. Reversing the test induces different results (252). All implants in the studies were tested in the same direction from the external side of the bone inwards.

Bone is a viscoelastic material. Bone consists mainly of the inorganic hydroxyapatite mineral and the pliant polymeric organic collagen type I besides other elements as proteoglycans and

glycoproteins. The mechanical properties of bone are affected by this bone composition and the degree of mineralisation (240). The composition makes bone a viscoelastic material (253-255). This means, that in the mechanical properties the stress (force/area on bone) not only depends on the strain (percent deformation of bone) but also on the time history of the strain and rates of loading. This time-dependent material behaviour gives rise to the mechanical phenomena as load ratio dependency of stiffness, stress relaxation and creep. During mechanical testing settings were accordingly chosen with a relatively low push out rate and a standardised hold after preload. A standardized preload established the contact position for starting the test.

Specimens were frozen until testing. This allowed mechanical testing of all specimens in a study at the same time with the same setup of push-out equipment. Freezing does not change the mechanical properties of trabecular bone, nor repeated thawing and freezing (256). Specimens were thawed at room temperature before testing. This reduced the influence of water content on the viscoelasticity of bone (257).

During mechanical testing the entire bone-implant-interface and surrounding bone was evaluated. The clearance between the implant and support jig was a critical factor in the test conditions. A small distance with tight fit leads to stress concentration (245) and vice versa. An opening of 0.5-0.7 mm shows low stress peaks (247). The clearance was chosen as recommended (247). By using a relative small opening the mechanical testing of the bone-implant interface was optimised at the cost of information about the mechanical properties of more distant bone surrounding the implant.

Exclusions mechanical testing

Study I: Two mechanical implant specimens in the control group were excluded before testing. One was excluded due to incomplete implant exposure after sectioning and one because of mix-up of implant devices during surgery.

Study II: One mechanical implant specimen in the control group was excluded due to oblique placement on the support jig during testing.

Study III: One mechanical implant specimen in the control group revealed incomplete implant exposure after sectioning and was excluded at time of testing.

Treatment groups of the excluded specimens were blinded until the mechanical testing of all implants was completed.

Mechanical parameters generated

All push-out parameters were normalised by the cylindrical surface area of the implant section tested, which transforms load data (N) into stress (Pa) (implant surface = $\pi \times \text{diameter} \times \text{length}$).

Table 9

	Implant diameter	Implant length
Study I	6.12 (0.14)	3.05 (0.38)
Study II	6.17 (0.10)	3.22 (0.19)
Study III	5.91 (0.13)	3.25 (0.38)

Table 9. Dimension of implant specimens for mechanical testing. Implants measured after mechanical testing. Data presented as mean (SD)

The normalised implant surface represents a smooth cylinder. The experimental implant surface is a porous coat with a relative higher surface area. The normalised load-displacement

data were therefore overestimated as to the true values. This did not imply a bias. Implants were similar and randomly distributed in the two treatment groups.

Maximum shear strength (Pa) was determined from the maximum force applied until failure of the bone-implant interface (figure 12). Mechanical failure at the bone-implant interface was regarded as the first peak on the stress-displacement curve. The linear slope in the elastic region of the stress-displacement curve defined the stiffness of the bone. The maximum shear stiffness (Pa/mm) was the maximum slope between 10 points successive sampled at testing (=0.03-0.04 mm). The energy required to cause mechanical failure was defined as the total energy absorption (J/m²) and calculated as the area under the stress-displacement curve until failure.

Mechanical parameter evaluation

The mechanical parameters reflected different aspects of implant fixation and depended on properties of the peri-implant tissue.

The *maximum shear strength* reflected the stress that the tissue-implant can tolerate at the interface before ultimate failure on a stress-displacement curve at the given displacement rate. The *maximum shear stiffness* reflected the rigidity or elastic modulus of the tissue at the tissue-implant interface, while *total energy absorption* was a measure of toughness or energy required to cause failure.

Type I collagen is distensible in tension but lacks resistance to bending. The mineral component in bone improves the bone stiffness (258). Increased bone stiffness may impair the ability to deform and adsorb energy making the material more brittle (258). During loading the brittle mineral confers stiffness and is protected by energy adsorption by collagen deformation and by noncollagenous proteins. These dissipate energy by reversibly breaking intrahelical bonds to provide hidden length (259, 260). In this respect the *energy absorption* in evaluating mechanical fixation and testing of an implant may seem more important.

During a gait cycle weight bearing of a prosthesis is transferred as stress forces to the bone-implant compound. Motion of the bone-implant beyond modest limits impairs the longevity of a prosthesis. This is due to impaired peri-implant bone growth and reduced protection against fluid-pressure at the interface inducing fibrous encapsulation and osteolysis by wear-particles from the prosthesis components (25, 26, 261). The movement at the bone-implant interface is determined by the stiffness and increased stiffness reduces the micromotion. In this respect *stiffness* in the mechanical implant evaluation is relevant. It may be argued, that loading of a prosthesis during gait applies stress substantially less than the point of total implant failure. Improving the mechanical fixation in terms of *strength* is in this respect less relevant.

Reproducibility of mechanical testing

Determination of reproducibility for the push-out test was not possible due to its destructive nature. Reproducibility of the estimated mechanical parameters was not done; since the estimated mechanical values were auto generated as Microsoft Excel spreadsheet formula.

STATISTICAL ANALYSIS

STATA statistical software (Stata 10.1, StataCorp, College Station, TX, USA) was used. Since normality in data distribution could not be assumed, statistical analysis was non-parametric. A

two-sample Wilcoxon rank-sum (Mann-Whitney) test was applied. Estimates were given as medians and interquartile ranges, and two-tailed p-values less than 0.05 were considered statistically significant.

4. RESULTS

SUMMARY OF STUDIES

Study overview of parameters of osseointegration and mechanical fixation of implants inserted in press-fit (study I), in an empty gap (study II) and in a gap impacted with morsellised bone allograft (study III) (table 10).

Table 10

		Study I:	Study II:	Study III:
• Histo-morphometry	• Interface: Bone in contact fraction	↑	– ³⁾	–
	• Gap region: Bone fraction	n/a	↑	↑
	• Intact bone region: Bone fraction	–	–	–
• Mechanical testing	• Max Shear Stiffness	–	↑	–
	• Total Energy Absorption	–	↑ ²⁾	–
	• Max Shear Strength	–	– ²⁾	–

Table 10. Summary of studies. Change of PTH relative to control. "↑" indicates significant increase ($p < 0.05$), "–" no significant differences, "¹⁾" $p = 0.07$, and "²⁾" $p = 0.08$, n/a = not available.

STUDY I

Hypothesis

Treatment with intermittently administered PTH increased the osseointegration and mechanical implant fixation of Ti-alloy porous coated implants inserted in press-fit with surrounding bone after 4 weeks in a canine model.

Histology

Woven bone was observed at the interface and also within the implant porosity in both treatment groups (figure 13). Around the PTH implants bone trabeculae adjacent to the implant were more voluminous in structure and a relative high density of bone was seen. No implants revealed a detrimental dense fibrous membrane.

Histomorphometry

PTH caused a significant 1.4 fold median increase in woven bone in contact with the implant (table 11). In the immediate adjacent region (0-500 μ m) and in the additional circumferential regions of intact host bone outside the drill hole (500-1000 μ m and 1000-2000 μ m) no significant differences in tissue density of bone types and fibrous tissue were observed.

Mechanical fixation

PTH caused no significant increase in mechanical parameters (figure 14). In the PTH group maximum shear strength was median (interquartile range) 3.7 (3.1-4.4) MPa and in control 4.0 (3.3-4.4) MPa. Maximum shear stiffness in the PTH group was 18.7 (12.7-24.2) MPa/mm and in control 17.3 (15.9-24.4) MPa/mm. Total energy absorption in the PTH group was 1016.5 (871.5-1229) J/m² and in control group 849.5 (698.5-1103) J/m².

Figure 13

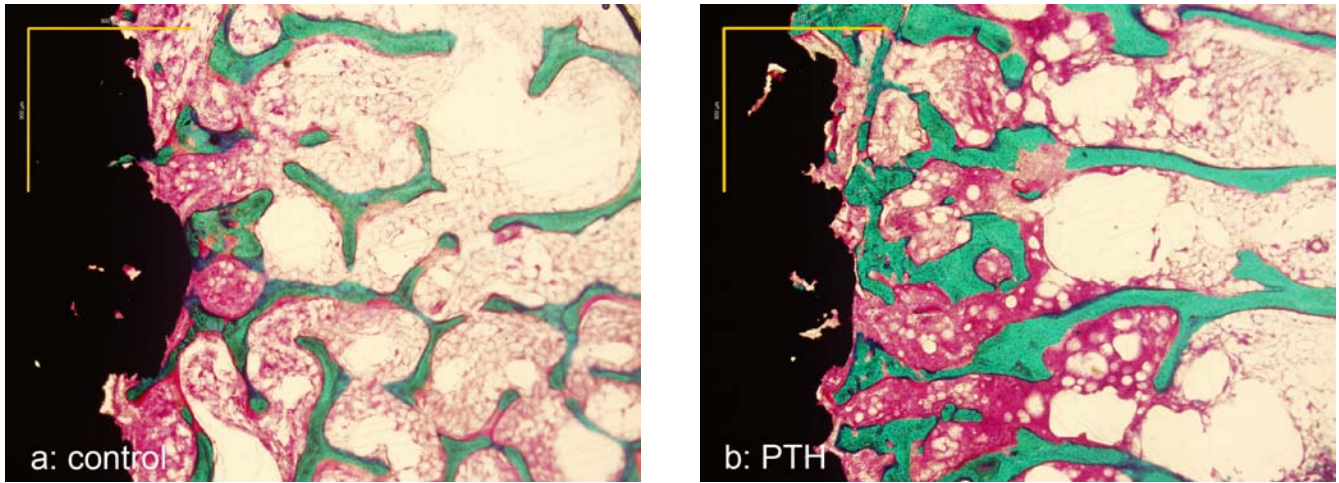

Figure 13. Photomicrograph of representative histological samples. Implant inserted in press-fit with surrounding bone. Control implant (figure a) and PTH implant (figure b). Staining technique basic fuchsin (red) and light green (green=bone). Black=Implant. Bar 900 μm .

Table 11

		Woven bone	Lamellar bone	Marrow	Fibrous
Interface	Control	11 (8-13)	6 (3-9)	84 (83-85)	0 (0-0)
	PTH	15 (13-18) *	3 (2-5)	80 (76-82) *	0 (0-0)
Region 0-500 μm	Control	10 (4-13)	13 (5-16)	78 (77-80)	0 (0-0)
	PTH	14 (10-17)	8 (6-13)	75 (72-79)	0 (0-1)
Region 500-1000 μm	Control	4 (2-7)	20 (15-23)	74 (73-78)	0 (0-0)
	PTH	7 (5-12)	13 (12-22)	77 (74-80)	0 (0-0)
Region 1000-2000 μm	Control	2 (1-3)	18 (16-20)	80 (79-82)	0 (0-0)
	PTH	3 (3-4) ¹⁾	15 (11-16) ¹⁾	83 (81-85)	0 (0-0)

Table 11. Study I: Press-fit. Fraction of bone, marrow-like and fibrous tissues at the implant surface, in the concentric region 0-500 μm , region 500-1000 μm , and region 1000-2000 μm around the implant. $n(\text{control}) = 9$, $n(\text{PTH}) = 8$. Mann-Whitney test, median, interquartile range. * $p < 0.05$, ¹⁾ $p = 0.07$ within region and PTH compared to control.

Figure 14

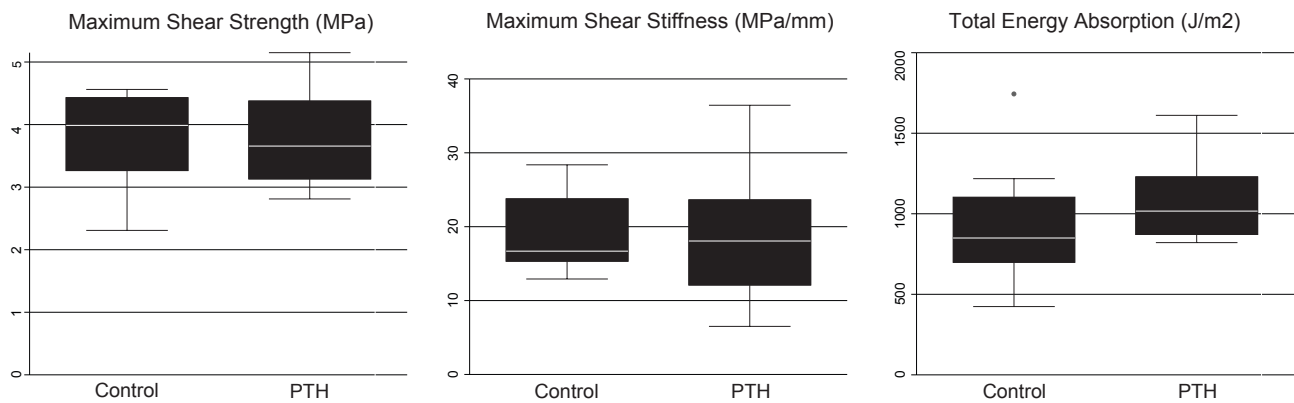

Figure 14. Study I: Press-fit. Mechanical results. Box plot. Maximum shear strength, maximum shear stiffness, and total energy absorption. $n(\text{control}) = 8$, $n(\text{PTH}) = 8$. Mann-Whitney test. No significant ($p \geq 0.05$) differences PTH compared to control.

STUDY II

Hypothesis

Treatment with intermittently administered PTH increased the osseointegration and mechanical implant fixation of Ti-alloy porous coated implants inserted in a gap in normal cancellous bone after 4 weeks in a canine model.

Histology

Implants treated with PTH showed abundant bone at the implant surface and in the gap (figure 15). The bone was immature with trabeculae of no specific orientation, was more connective and thicker than in the control group. In the PTH specimens, trabeculae were more abundant. They appeared thinner in the gap region compared to the region of intact host bone. Fibrous tissue was observed in 6 PTH implants and 5 controls located in the inner gap and at the bone-implant interface.

Histomorphometry

Treatment with PTH caused a significant increase in bone in the 1 mm peri-implant gap (table 12) with a 2.5 fold median increase in the outer half and 2.4 fold increase in the inner part. At the interface, PTH showed a non-significant difference in bone in contact by median 1.6-fold ($p=0.07$). No significant differences in fibrous tissue were seen in the gap or at interface. In the peri-implant region of the host bone not subjected to implantation no differences in bone or fibrous tissue was found.

Mechanical fixation

Treatment with PTH significantly increased maximum shear stiffness and total energy absorption (figure 16). No significant increase in maximum shear strength was found. Shear stiffness was increased 2.0 fold with median (interquartile range) PTH 17.4 (12.7-39.7) MPa/mm and control 8.8 (3.3-12.4) MPa/mm. Energy absorption was 1.7 fold higher with median (interquartile range) of PTH 781 (595-1198) J/m² and control 470 (189-596) J/m². Shear strength showed a 1.5 increase with PTH 3.0 (2.6-4.9) MPa and control 2.0 (0.9-3.0) MPa ($p=0.08$).

Figure 15

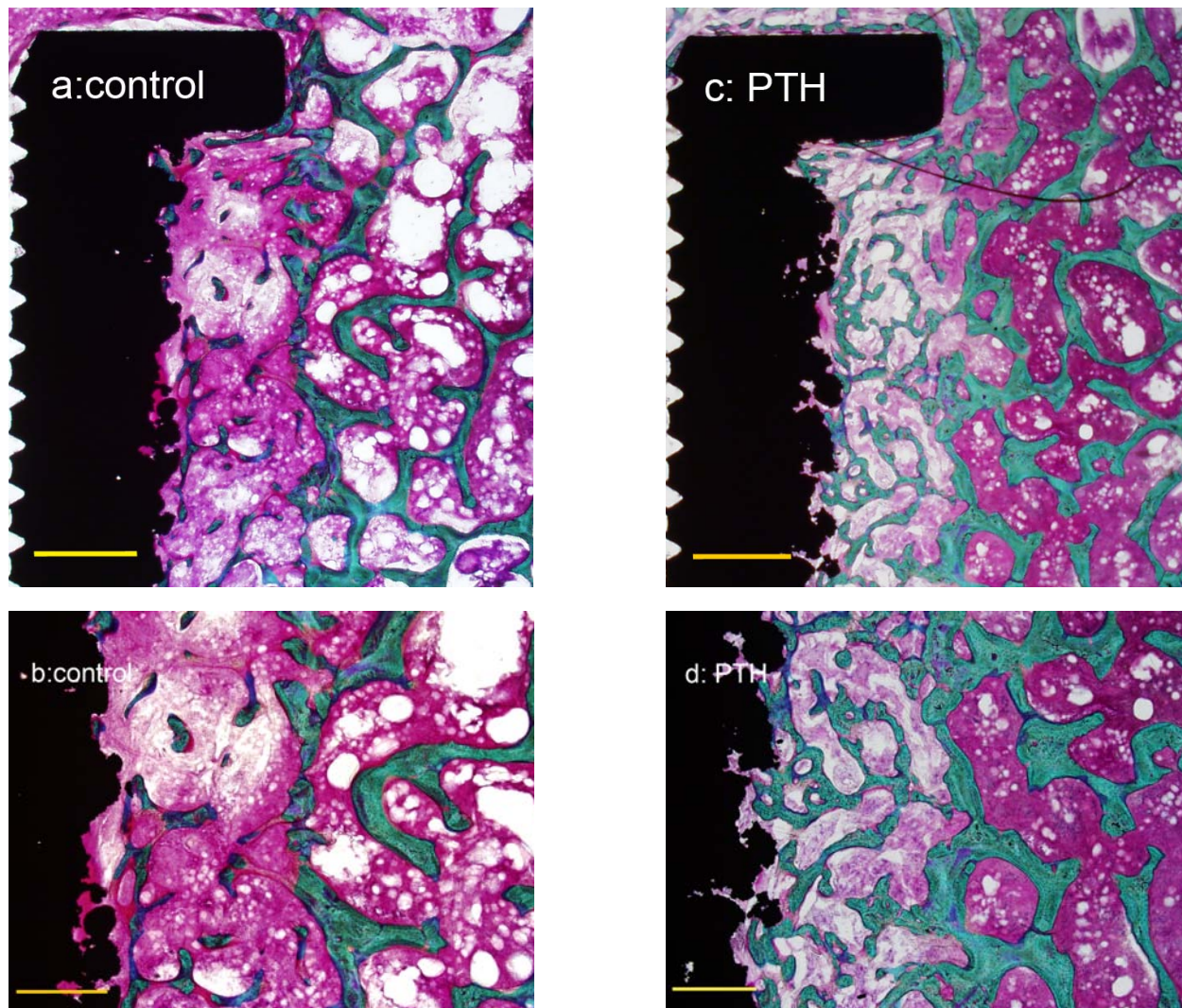

Figure 15. Representative histological samples. Implant inserted in an empty gap. Control implant (figures a+b) and PTH implant (figures c+d). Green is bone and black is implant. Bar 1000 µm in images figure a+c and bar 500 µm in images figure b+d.

Table 12

		Bone	Marrow	Fibrous
Interface	Control	10 (7-12)	77 (70-88)	8 (0-21)
	PTH	16 (11-20) ¹⁾	74 (56-80)	7 (0-35)
Inner gap	Control	13 (11-18)	82 (77-85)	2 (0-7)
	PTH	33 (26-36)***	60 (53-69)**	3 (0-14)
Outer gap	Control	10 (6-14)	90 (86-94)	0 (0-0)
	PTH	27 (20-37)**	73 (63-80)**	0 (0-0)
Intact bone	Control	22 (19-23)	78 (77-81)	0 (0-0)
	PTH	22 (18-30)	78 (70-82)	0 (0-0)

Table 12. Study II: Gap. Fraction of tissue at implant surface, in a 1 mm gap region divided in two of an outer gap (500 µm) and inner gap, and in a region of non-implanted intact bone outside the gap (1000 µm), n(control) = 10, n(PTH) = 8. Mann-Whitney test, median, interquartile range. **p<0.01, *** p < 0.001, ¹⁾ p = 0.07, PTH compared to control within region.

Figure 16

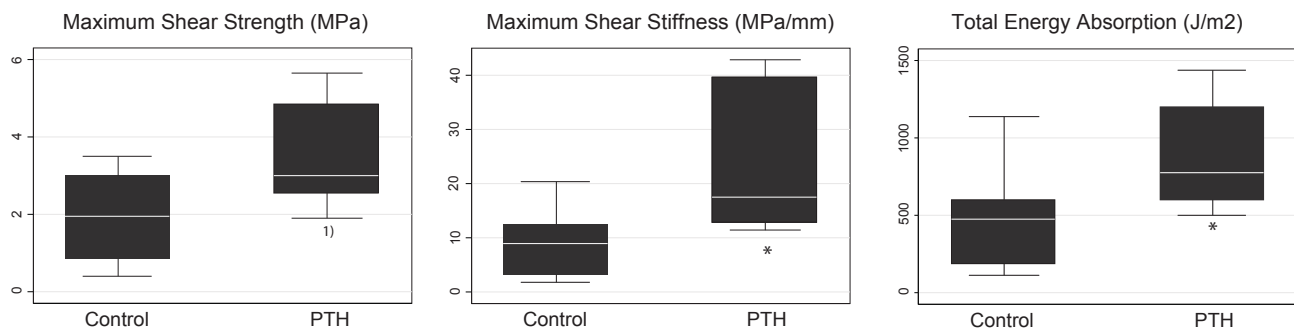

Figure 16. Study II: Gap. Mechanical results. Box plot, median, quartiles, sample range. Maximum shear strength, maximum shear stiffness, and total energy absorption. n(control) = 9, n(PTH) = 8. Mann-Whitney test, * p < 0.05, ¹⁾ p = 0.08, PTH compared to control.

STUDY III

Hypothesis

Treatment with intermittently administered PTH increased new bone formation, preserve the allograft, and increased the mechanical fixation of Ti-alloy porous coated implants inserted in a gap of normal cancellous bone with impacted morsellised bone allograft around the implants after 4 weeks in a canine model.

Histology

New bone and graft filled the gap in both the control and PTH groups (figure 17). A common observation in the PTH group was of allograft chips embedded in new bone with bridging trabeculae to neighbouring graft chips and thereby displaying high connectivity. Resorption lacunae on the allograft were sparse. At the interface, new bone dominated implant contact as an intervening bone layer between bone graft and implant surface. In the control group new bone formation appeared more rare with less connectivity.

Histomorphometry

PTH caused a significant increase in the amount of bone in the gap (table 13). A significant 1.4 fold median increase in new

bone was seen. There was no significant difference in the amount of allograft in the PTH group compared to control. No increase in formation of new bone was observed on the surface of the implants in the PTH group. An only sparse and unaltered amount of allograft was observed on the surface.

PTH did not improve total bone fraction in the intact host bone as no differences were observed in the 1000 µm circumferential region outside the original drill hole. Total bone density median (interquartile range) for PTH was 31 (27-36) % and control 33 (22-38) %. Density of marrow tissue for PTH was 69 (64-73) % and control 67 (62-78) %, and no fibrous tissue was observed in either treatment groups.

Mechanical fixation

Implants surrounded by allograft and treated with PTH or control showed no significant differences in the mechanical parameters (figure 18). In the PTH group maximum shear strength was median (interquartile range) 4.8 (3.5-5.3) MPa and in control 4.6 (3.6-6.1) MPa. Maximum shear stiffness in the PTH group was 30.1 (23.6-38.3) MPa/mm and in control 26.5 (25.5-35.7) MPa/mm. Total energy absorption in the PTH group was 963 (780-1339) J/m² and in control group 962.5 (828-1704) J/m².

Figure 17

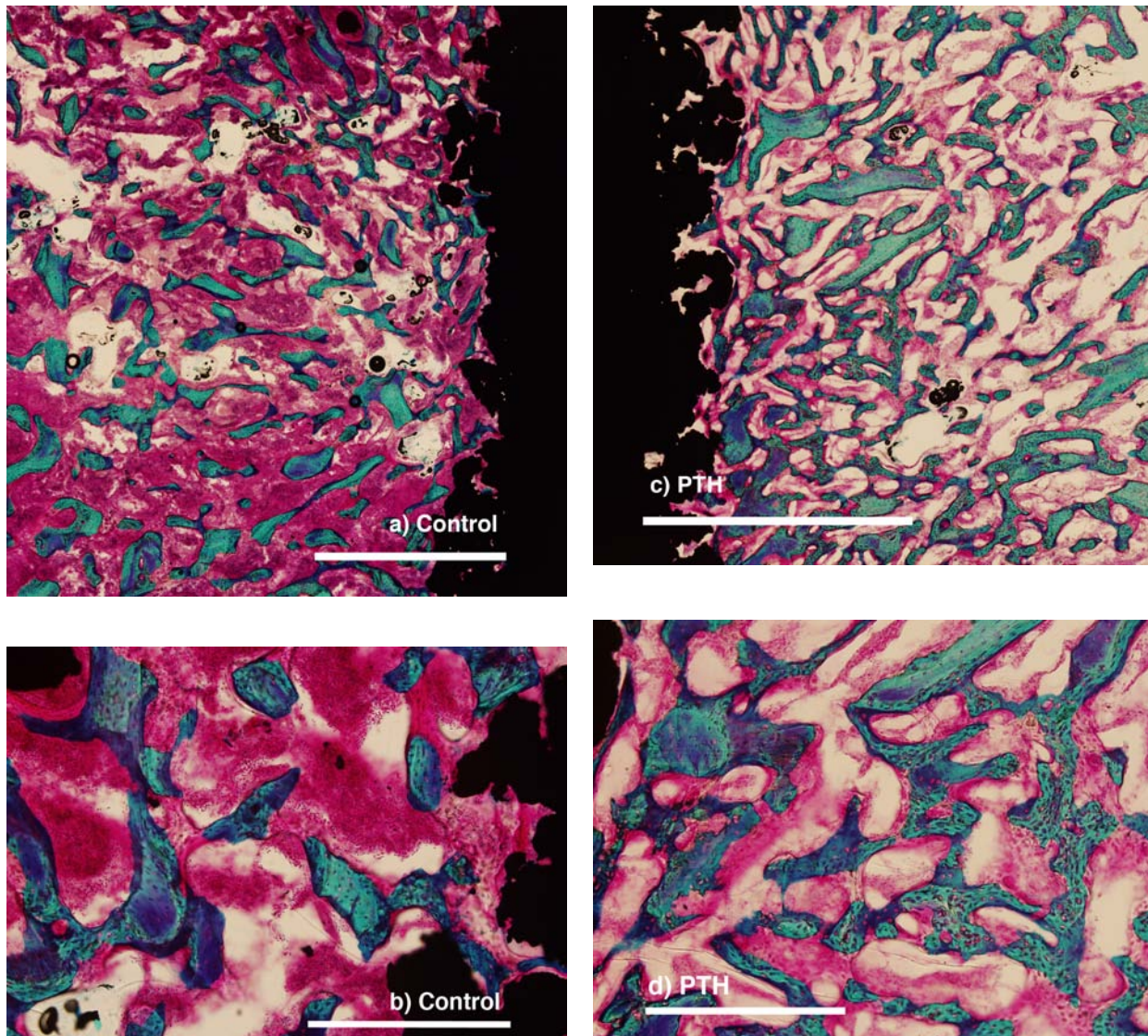

Figure 17. Photomicrograph of representative histological samples. Implant inserted in a gap with impacted morsellised bone graft. Control implant (figures a+b) and PTH implant (figures c+d). Staining technique basic fuchsin (red) and light green (green=bone). Black=implant. Bar 2000 μm in images figure a+c and bar 500 μm in images figure b+d

Table 13

		Total bone	New bone	Old bone	Marrow	Fibrous
Interface	Control	12 (8-16)	10 (7-15)	1 (1-2)	87 (84-92)	0 (0-0)
	PTH	12 (9-16)	12 (8-14)	1 (1-2)	86 (83-88)	0 (0-1)
Inner gap	Control	26 (23-30)	14 (13-16)	13 (9-17)	73 (70-75)	0 (0-0)
	PTH	33 (28-34)	20 (16-22) ¹⁾	13 (11-15)	67 (65-70)	0 (0-0)
Outer gap	Control	26 (23-27)	15 (14-16)	11 (8-12)	74 (73-77)	0 (0-0)
	PTH	30 (27-32) *	21 (17-23) *	8 (7-12)	70 (68-73) ¹⁾	0 (0-0)

Table 13. Study III: Graft. Fraction of new bone, old bone, total bone, marrow-like and fibrous tissues at implant surface, and in concentric peri-implant gap of 2.5 mm divided in an outer gap (1500 μm) and inner gap. n(control) = 10, n(PTH) = 8. Mann-Whitney test, median, interquartile range. * $p < 0.05$, ¹⁾ $p = 0.07$, PTH compared to control within region.

Figure 18

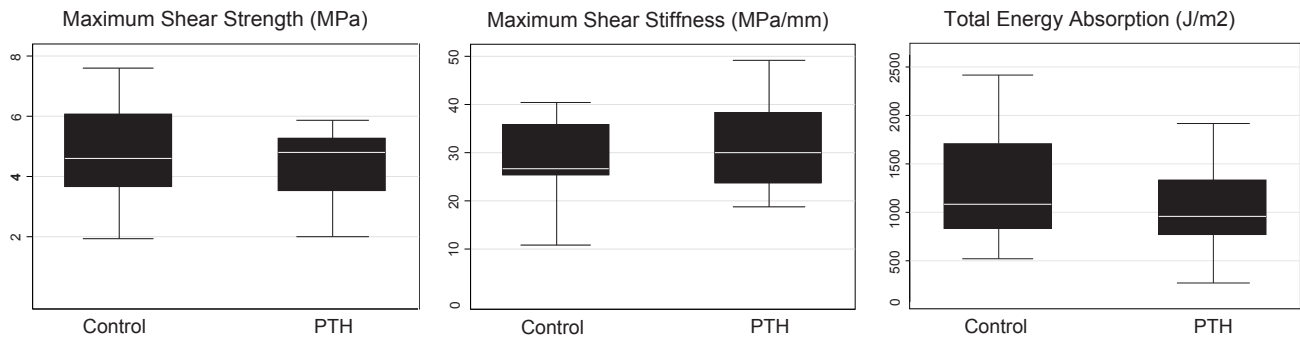

Figure 18: Study III. Graft. Mechanical results. Box plot. Maximum shear strength, maximum shear stiffness, and total energy absorption. $n(\text{control}) = 9$, $n(\text{PTH}) = 8$. Mann-Whitney test. No significant ($p \geq 0.05$) differences PTH compared to control.

5. DISCUSSION

STUDY I, II, III

The studies in this thesis were based on the challenges that the orthopaedic surgeon is faced with in total joint replacements. Press-fitting the prosthetic component into the prepared cancellous bone bed aims at stabilizing the prosthesis at surgery. Yet, implant porosity and subsequent bone resorption call for bone formation in order to maintain implant stability and seal the bone-implant interface against wear particles and resulting osteolysis. The effect of PTH(1-34) in *press-fit* implant insertion forms the basis of *study I*. In spite of intended insertion in *press-fit*, gaps exist around the implant at the time of insertion. In *study II* we examined whether PTH(1-34) could improve implant fixation in the more challenging situation of *empty gaps* surrounding the implant. In primary and revision surgery settings, even larger bone defects may complicate and require bone grafting in order to consolidate implant stability and fill defects. The effect of PTH(1-34) on *bone-grafted* implants comprises *study III*.

The papers in this thesis showed that human PTH(1-34) could stimulate cancellous bone healing indicating that the effect of PTH(1-34) in the given manner is anabolic. In a canine model PTH(1-34) increased peri-implant bone at implants inserted *press-fit*, in an *empty gap*, and in a gap impacted with bone graft. In *study I*, PTH(1-34) increased osseointegration of implants inserted in *press-fit* by increasing new bone formation at the implant surface. In the gap studies II and III, PTH(1-34) improved the bone formation in the gaps that surrounded the implants. PTH(1-34) increased the implant fixation of implants in a gap (*study II*), while fixation was unaltered of implants secured in *press-fit* (*study I*) and implants impacted in bone graft (*study III*). In *study III* the volume of bone graft was unaltered, while concurrent bone formation improved. Although the PTH(1-34) treatment in all models stimulated bone deposition in healing bone, bone in intact non-implanted bone was not influenced.

Much research has been accomplished in animal models examining the role of PTH in bone remodelling - less so in models of bone repair. The large animal study is an important stride between the experimental studies and the human trial for developing new technologies in implant fixation. Given that the models were experimental, a confined standardised implant element may be evaluated. However, models were experimental and hence

clinical adaptations. Therefore, extrapolation of results should be done in the context of the used experimental model and the design. The used experimental models were designed to imitate a cementless total joint replacement with various implant designs inserted in canine cancellous bone. The observation period represents a cross-section of the achieved peri-implant healing process at the given time point and PTH(1-34) was administered in a single dosage.

We decided to do all implant studies in the same series of animals utilising the available bone sites suitable for implant research. This approach had some advantages and disadvantages. The advantages included ethical, economical and time. Although we did not directly compare results in-between the three studies, it would be an advantage that we knew that the same dose was given in the all studies. On the other hand, this approach also carries risks, as loss of animals or error would affect all studies. Further changes in PTH dose or observation period was not possible.

We would have liked to have done a proper dose-response study prior to the studies presented. However, this would have required a large number of experimental animals, which was not possible for a number of reasons among these ethical and economical. As described earlier we estimated the optimal dose based on the literature. It is therefore a premise for this study that the optimal dose was not known in a canine model of bone repair.

In our studies we experienced loss of test animals. As we could not do immediate autopsy to establish whether the test animals had unknown illnesses, we had to look for other reasons for these sudden animal deaths. Consultations with various experts lead to the suspicion that the carrier TFA could have a toxic effect. In order to salvage the study and prevent further animal deaths we decided to change to GMP grade PTH(1-34). According to the manufacturer the dose and kinetics were similar. We recognize that different carriers may potentially change the effect of a given treatment, but in this case we found the substitution reasonable and did not expect any major differences in the effect exerted on bone.

The loss of the two animals in the treatment group was unfortunate. The study set-up allows for loss of animals. It is however clear that a loss of animals increased the risk of misinterpretation of data.

The aim of PTH treatment was to improve osseointegration and implant fixation.

Study I demonstrated that PTH(1-34) treatment could significantly improve the amount of new bone in contact with the implant surface. The osseointegration (as originally defined by Branemark (30)) improved, but this did not gain effect mechanically. We found PTH(1-34) improved bone formation at the implant but not in the innermost region adjacent to the implant. Study I used a press-fit model, which implied that a slightly oversized implant was inserted into a predrilled cavity. Inserting an implant in press-fit secured the implant initially and confined the need for bone repair to the bone only just at the implant surface. A potential mechanical improvement could therefore be expected to relate to the improved bone at the interface. From previous studies we know that implants inserted in this model, generally have a good mechanical fixation at the 4 week observation period. We know that only very potent adjuvant therapies can significantly increase the mechanical fixation. On the other hand adjuvant therapies, which may increase bone resorption at the interface, can potentially decrease fixation and increase the risk of loosening. Therefore implant studies using a press-fit setting is absolutely necessary in order to evaluate treatments. It is evident from the results that the increase in woven bone was not sufficient to increase the mechanical fixation. We have seen similar results in previous studies using other adjuvant therapies (262, 263). However it is interesting that an increase in woven bone was observed without decreasing the amount of lamellar bone, and the increase in bone was observed in the primary area of healing. Although intermittent PTH(1-34) did not improve the mechanical fixation of the implant inserted in press-fit, the improved osseointegration may contribute to long-term implant survival by sealing the interface.

Study II demonstrated, that PTH(1-34) treatment significantly improved the bone formation in the peri-implant empty gap. Although study II failed to demonstrate significant improvement in bone at the implant surface, the increased bone in the gap was sufficient to increase implant fixation. Study II used a gap-model of implants inserted in an empty gap. This imitated the clinical situation in which peri-implant spaces exist around the implant. These spaces represented areas with no structural support of the prosthesis, and at the same time extensions of an effective joint space. In this model the bone repair exceeded the need at the implant surface for stabilizing the implant. Inserting implants in a gap strained the needs for subsequent stabilisation of the implant by bone growth. PTH(1-34) improved implant fixation and bone healing around the implant. Previous studies in this implant model have shown, that differences in bone volume can be established in a 1 mm gap. Intermittent PTH(1-34) improved the bone volume in the entire gap with bone expanding the gap to the implant surface and no significant differences in fibrous tissue. In a rat study in tibia, Skripitz demonstrated, that intermittent PTH(1-34) does not improve ingrowth distance into a bone conduction chamber. However, PTH(1-34) increased the bone formation behind the ingrowing bone-formation-frontier (106, 107, 201). In the 1 mm gap we used in our study, the formation frontier apparently exceeded the gap at this time point, which implies, that a critical gap of larger size could have been evaluated. Regenerating bone appears to be more responsive to the anabolic actions of PTH(1-34) than intact remodelling bone (106, 107). In study II, bone in gap improved, while no difference was observed outside the gap in intact bone. The difference could be related to the extent by which bone repair is needed in healing bone as to normal remodelling bone (170).

Relating study I and II to research on the anabolic response of intermittent PTH in joint replacements confines to experimental studies in the rat and rabbit model. Intermittent treatment with PTH improves mechanical fixation of screw implants inserted transcortically in normal bone (108, 164, 167) or as rods in cancellous bone of low bone density (127, 168-170, 174). A positive effect on bone formation has been seen with implants (screws and rods) inserted in normal bone (108, 172), aged bone (173), and bone of low bone density (171). The use of a model in lower animal species, the implant type, and the transcortical implant localisation explains the mechanical divergence compared to our press-fit model. To our knowledge, no studies have evaluated implants inserted in a gap.

Bone graft is an inert material in which the mechanical properties *per se* remain unaltered over time. As part of the initial healing process bone graft becomes embedded in fibrous / granulation tissue. Graft material induces bone formation and resorbes as it remodelles. When loading the bone graft mechanically, bone chips become interlocked. PTH is anabolic on bone. An expected outcome of study III would be an increase in the amount of new bone in the allograft and allograft being preserved leading to improved mechanical fixation in the PTH(1-34) treatment group. Study III demonstrated, that PTH(1-34) treatment increased formation of new bone within the allografted gap and increased total bone. While bone formation improved, the volume of allograft was unaltered. In the dosage used, intermittent PTH(1-34) improved bone formation, with no significant catabolic effect on bone. Although intermittent PTH stimulates osteoblast activity, increased osteoclast activity as part of the PTH response is suggested. We did not see differences in old bone, and this might support that PTH(1-34) did not significantly induce bone resorption. Concurrent with the unaltered volume of old bone and the improved new bone in the gap, the mechanical fixation was unaltered. This implies, that at this time point the mechanical fixation constituted of the bone graft supporting the implant and not new bone. However, in general, in the situation of peri-implant defects impacted with bone graft new bone formation within the graft is essential as graft in time resorbes and the new bone succeeds the supportive role securing implant integration and fixation. Bone at interface did not improve, which could be subscribed to impaction and time of observation (79, 80)

CLINICAL PERSPECTIVE

The results from study I-III are promising. PTH increased bone healing and mechanical fixation of orthopaedic implants in higher animal species, and a clinical application may seem reasonable. Study I-II related to the setting of a primary arthroplasty with implants inserted in normal bone. Study II-III related to the revision setting, in which various defects exist around the implant, which might restrict implant stability and may necessitate bone grafting.

When considering the clinical perspective in treatment with PTH at joint replacement surgery, considerations apply.

Retrieval studies have shown, that bone ingrowth to the prosthesis varies (64-66). To gain stability of an implant it is proposed that a certain minimum of bone integrates the implant in every dimension. The question still remains as to what extent of bone contact clinically correlates to stability and hence osseointegration. Some well-functioning acetabular and femoral stems may become fixed by fibrous tissue instead of bone ingrowth (5, 23) and even if one or two point bone contact can be demonstrated this need not represent actual osseointegration of the

entire implant (264). Retrieval studies have shown, that in the proximal part of the femur more bone ingrowth is seen at the anterior and medial sides of femoral components than the lateral and posterior surfaces. This part of the femur represents the metaphysis. In these regions porous-coated implants often have bone extending from the coating to the proximal femoral cortex. As the femur narrows from metaphysis to diaphysis, bone ingrowth becomes more circumferential. The clinical potency of PTH in integrating a joint replacement component may diverse along the prosthetic component depending on bone localisation and vascularity variations.

One concern regarding the use of intermittent PTH as adjuvant therapy in implant fixation is the effect on bone after terminating the treatment. Discontinuation of PTH has been shown to lead to loss of the anabolic effect of PTH on bone in rats (224, 265, 266). While a successful osseointegration maintains its bone anchorage over a long period, the PTH osteoconductive response may then be short lived. Further studies are needed beyond the period of the initial PTH treatment in relation to the subsequent remodelling, and this in higher animal species of relevant size and implant type. Intermittent treatment with PTH followed by bisphosphonates may be relevant, as shown in the treatment of osteoporosis (267).

FUTURE RESEARCH

Further studies are needed in large animal models, and attention should be focused on:

- determination of PTH's bone healing potential with implants in larger empty gaps, with longer treatment periods, in a dose-response study and weight bearing
- bone remodelling and effect on implant fixation after terminating PTH treatment
- local administration of PTH in applications securing intermittent dosage
- concurrent bisphosphonate treatment in combined and/or alternated dosage with PTH
- osteoconductive implants (HA coated, surface textured, RGD coated) in combination with PTH treatment
- local BMP treatment in combination with PTH treatment

6. CONCLUSION

The studies presented in this thesis demonstrated, that intermittent administration of human PTH(1-34) increased bone healing around orthopaedic implants inserted in press-fit in bone, in an empty gap and in a gap impacted with morsellised bone graft. This increase was notable in the implant model with peri-implant gaps, where no other elements than the pure bone stimulation improved the mechanical fixation. These results were obtained in a study with no knowledge of an optimal dose from previous dose-response studies. We are therefore convinced, that with administration of an optimal dose the effect will be much greater.

7. SUMMARY

INTRODUCTION

Primary joint replacements generally function well with excellent clinical results. However, failure rates for young patients are still

high and increasing in number. The long-term survival of an uncemented prosthesis is influenced by multiple factors depending on host physiology as well as properties of implanted material, initial mechanical stability, early osseointegration, and the surrounding bone.

Parathyroid hormone is the principal regulator of calcium homeostasis and involved in the control of bone remodelling. Parathyroid hormone administered intermittently increases bone formation and mass by osteoblast stimulation. Early osseointegration and implant fixation could potentially be enhanced with adjuvant parathyroid hormone treatment.

The aim of the studies in this PhD thesis was to determine if implant fixation of experimental implants can be improved with adjuvant intermittent administration of parathyroid hormone.

STUDIES

All studies used an experimental canine model of early implant fixation inserting porous coated titanium alloy implants with no weight bearing in a bed of cancellous bone. The study design was un-paired. Test animals were randomised to PTH (1-34) 5 µm/kg daily for 4 weeks. Implant fixation was defined by mechanical stability and osseointegration.

Study I investigated the effect of parathyroid hormone on implant fixation of implants inserted press-fit with surrounding bone in the proximal tibia of 20 canines. Histomorphometric analysis showed increased amount of new bone in contact with the implant. No improvement was observed in the surrounding bone. PTH did not increase mechanical fixation in push-out test.

Study II investigated the effect of parathyroid hormone on implant fixation of implants surrounded by a critical 1 mm gap. Implants were inserted in the tibia of 20 canines. Bone density was increased in the inner gap and outer gap with PTH treatment. Bone at implant interface improved with PTH but did not achieve significance. Push-out testing showed that PTH increased mechanical implant fixation in shear stiffness and total energy absorption. Shear strength was not significantly increased.

Study III investigated the effect on implant fixation of implants surrounded by a 2.5 mm gap in which morsellised allograft was impacted. Implants were inserted in 20 canines in the humerus. Histomorphometric analysis showed that PTH increased the amount of new bone within the gap, but not in contact the implant. There were no differences in amount of allograft. The push-out testing showed no differences in mechanical parameters.

CONCLUSION.

The studies in this PhD thesis demonstrated that parathyroid hormone increases bone healing around implants in situations of insertion in press-fit or in more challenging environments of empty and grafted gaps. Early fixation was increased in implants with gaps, in which pure gap bone stimulation improved fixation. This warrants further preclinical studies.

8. APPENDIX

Table 1

Model	Animal	PTH	Dosage	Author (Ref.)
I	Rabbit	hPTH(1-34)	6 µg/kg/day, 3 days weekly, 4+8 weeks	Corsini (164)
I	Rat	hPTH(1-34)	15+60+240 µg /kg/day, daily, 42 days	Skripitz (106)
I	Rat	hPTH(1-34)	60 µg/kg, daily, 6 weeks	Skripitz (107)
I	Rat	hPTH(1-34)	60 µg/kg/day, 3 days weekly, 1+2+4 weeks (no effect mechanically at 1 week)	Skripitz (108)
I	Rat	hPTH(1-34)	60 µg/kg/day, 3 days weekly, 2+4 weeks.	Skripitz (172)
I	Rat	hPTH(1-34)	60 µg/kg/day, 3 days weekly, 4 weeks	Mair (173)
I	Rat	hPTH(1-34)	60 µg/kg/day, daily, 4 weeks	Skripitz (166)
I	Rat	hPTH(1-34)	60 µg/kg/day, daily, 4 weeks	Skripitz (167)
I + L	Rat	hPTH(1-34)	25 µg/kg/day, 5 days weekly, 6 weeks	Gabet (169)
I + L	Rat	hPTH(1-34)	30 µg/kg/day, 3 days weekly, total treatment 22-29 weeks (1-8 weeks after implantation)	Shirota (171)
I + L	Rat	hPTH(1-34)	30 µg/kg/day, daily, 5 days weekly, 2+4 weeks	Ohkawa (170)
I + L	Rat	hPTH(1-34)	40 µg/kg/day, 5 days weekly, 8 weeks	Dayer (174)
I + L	Rat	hPTH(1-34)	40 µg/kg/day, daily, 8 weeks	Dayer (168)
I + L	Rat	hPTH(1-34)	5, 25 and 75 µg/kg/day, 5 days weekly, 8 weeks (no effect of 5 µg/kg/day)	Gabet (127)
I + L	Rat	hPTH(1-34)	60 µg/kg/day, daily, 2 weeks	Skripitz (165)
"I"	Rat	hPTH(1-34)	100 µg/kg, weekly, 8 weeks ("I": Bone growth on HA-block)	Kamo (175)
F	Human	hPTH(1-34)	20+40 µg/kg/day, daily, 8 weeks	Aspenberg (161)
F	Mice	hPTH(1-34)	30 µg/kg/day, daily, 2 weeks	Kakar (182)
F	Mice	hPTH(1-34)	40 µg/kg/day, daily, 1+3 weeks	Kaback (202)
F	Monkey	hPTH(1-34)	0.75+7.5 µg/kg/day, twice weekly, 3 weeks	Manabe (163)
F	Rabbit	PTH(1-34)	10+40 µg/kg/day, daily, 3 weeks (no effect 40 µg/kg/day – model limitations), PTH type n/a	Tsiridis (160)
F	Rabbit	hPTH(1-34)	10 µg/kg/day, daily, 4 weeks	Morgan (153)
F	Rat	hPTH(1-34)	10 µg/kg/day, daily, 1+3 weeks (no effect at 3 weeks)	Rowshan (268)
F	Rat	hPTH(1-34)	10 µg/kg/day, daily, 4 weeks	Nakazawa (154)
F	Rat	hPTH(1-34)	10 µg/kg/day, daily, 4+6 weeks	Nakajima (155)
F	Rat	hPTH(1-34)	10+30 µg/kg/day, 3 times weekly, total treatment of each dosage 3-15 weeks (3 weeks are before implantation)	Komatsubara (162)
F	Rat	hPTH(1-34)	200 µg/kg/day, daily, 3+8 weeks	Andreassen (129)
F	Rat	hPTH(1-34)	40 µg/kg/day, daily, 2+4+8 weeks	Sloan (156)
F	Rat	hPTH(1-34)	5+30µg/kg/day, daily, 21+35 days (no histomorphometric or mechanical effect of 5 µg/kg/day at 21 days, or mechanical effect of 5 µg/kg/day at 35 days)	Alkhiary (152)
F	Rat	hPTH(1-34)	50 µg/kg/day, 5 days weekly, 6 weeks (mute mechanical response in open compared to closed fractures)	Tagil (159)
F	Rat	hPTH(1-34)+ hPTH(1-31)	60 µg/kg/day, daily, 8 weeks (sequential 8 weeks on and 8 off)	Andreassen (157)
F	Rat	hPTH(1-34)	60+200 µg/kg/day, daily, 20+40 days (no mechanical effect of 60 µg/kg/day at 20 days)	Andreassen (104)
F	Rat	hPTH(1-34)	80 µg/kg/day, daily, 3 weeks	Holzer (158)
F + L	Rat	hPTH(1-34)	100 µg/kg/day, once a week, 4 weeks	Nozaka (138)
F + L	Rat	hPTH(1-84)	15+150 µg/kg/day, daily, 30 days	Jahng (151)
F + L	Rat	hPTH(1-84)	15+150 µg/kg/day, daily, 30 days	Kim (103)
"F"	Rabbit	hPTH(1-34)	10 µg/kg/day, daily, 6 weeks ("F": spinal fusion model)	O'Loughlin (204)
"F"	Rat	hPTH(1-34)	10+100 µg /kg/day), daily, 8 weeks or sequential 4 weeks on/off ("F"=structural graft model)	Hashimoto (269)
DO	Rabbit	hPTH(1-84)	25 µg/kg/day, daily, 20+30 days	Aleksyniene (177)
DO	Rabbit	hPTH(1-84)	5+25 µg/kg/day, daily, 35 days	Aleksyniene (176)
DO	Rat	hPTH(1-34)	60 µg/kg/day, every second day, 30 days	Seebach (139)

Table 1: PTH evaluated in models of bone repair.

All known studies to our knowledge. PTH dosage administered systemically. Human PTH=hPTH. Model Abbreviations of regenerating bone: I=Implant related, F=Fracture, DO=Distraction osteogenesis, L=low-density bone/osteoporotic bone/OVX/ORX model. n/a = not available. No canine studies are available.

Table 2

Model	Animal	PTH	Dosage	Author (Ref.)
I	Rabbit	hPTH(1-34)	6 µg/kg/day, 3 days weekly, 4+8 weeks	Corsini (164)
I	Rat	hPTH(1-34)	60 µg/kg/day, 3 days weekly, 1+2+4 weeks (no effect mechanically at 1 week)	Skripitz (108)
I	Rat	hPTH(1-34)	60 µg/kg/day, 3 days weekly, 2+4 weeks.	Skripitz (172)
I	Rat	hPTH(1-34)	60 µg/kg/day, 3 days weekly, 4 weeks	Mair (173)
I + L	Rat	hPTH(1-34)	30 µg/kg/day, 3 days weekly, total treatment 22-29 weeks (1-8 weeks after implantation)	Shirota (171)
I + L	Rat	hPTH(1-34)	30 µg/kg/day, daily, 5 days weekly, 2+4 weeks	Ohkawa (170)
I + L	Rat	hPTH(1-34)	40 µg/kg/day, 5 days weekly, 8 weeks	Dayer (174)
I + L	Rat	hPTH(1-34)	5, 25 and 75 µg/kg/day, 5 days weekly, 8 weeks	Gabet (169)
I + L	Rat	hPTH(1-34)	5, 25 and 75 µg/kg/day, 5 days weekly, 8 weeks (no effect of 5 µg/kg/day)	Gabet (127)
"I"	Rat	hPTH(1-34)	100 µg/kg, weekly, 8 weeks ("I": Bone growth on HA-block)	Kamo (175)
DO	Rat	hPTH(1-34)	60 µg/kg/day, every second day, 30 days	Seebach (139)
F	Monkey	hPTH(1-34)	0.75+7.5 µg/kg/day, twice weekly, 3 weeks	Manabe (163)
F	Rat	hPTH(1-34)	10+30 µg/kg/day, 3 times weekly, total treatment of each dosage 3-15 weeks (3 weeks are before implantation)	Komatsubara (162)
F	Rat	hPTH(1-34)	50 µg/kg/day, 5 days weekly, 6 weeks	Tagil (159)
F	Rat	hPTH(1-34)	50 µg/kg/day, 5 days weekly, 6 weeks (mute mechanical response in open compared to closed fractures)	Tagil (159)
F + L	Rat	hPTH(1-34)	100 µg/kg/day, once a week, 4 weeks	Nozaka (138)
N	Canine	hPTH(1-34)	0.375µg/kg/day, 3 days weekly, 24 weeks	Zhang (146)
N	Canine	hPTH(1-34)	0.375µg/kg/day, 3 days weekly, 24 weeks	Zhang (148)
N	Canine	hPTH(1-34)	0.83 µg/kg/day, 5 days weekly, 24 weeks	Boyce (149)
N	Canine	hPTH(1-34)	0.83 µg/kg/day, 5 days weekly, 24 weeks	Ma (150)
N	Rat	hPTH(1-38)	Intermittent, 50 to 1000 µg/kg/day, 5 days weekly, 2-8 weeks	Jerome (136)
N	Rat	hPTH(1-38)	50 - 1000 µg/kg/day, 5 days weekly, 2-8 week (all doses anabolic on bone)	Jerome (136)
L	Monkey	hPTH(1-34)	10 µg/kg/day, 3 days weekly, 3 months	Jerome (132)
L	Monkey	hPTH(1-34)	10 µg/kg/day, 3 days weekly, 6 months	Jerome (205)
L	Rat	hPTH(1-34)	1-5 µg/kg/day, 3 days weekly, 25 weeks	Hori (141)
L	Rat	hPTH(1-34)	12.5 µg/kg/day, 6 days weekly, 8 weeks	Tada (270)
L	Rat	hPTH(1-34)	30 µg/kg/day, 3 days weekly, 8 weeks	Takano (271)
L	Rat	hPTH(1-34)	30 µg/kg/day/day, 5 days weekly, 1 and 3 weeks	Nishida (199)
L	Rat	hPTH(1-34)	80 µg/kg/day, 5 days weekly	Li (203)
L	Rat	hPTH(1-34)	80 µg/kg/day, 6 days weekly, 5 and 15 weeks	Mosekilde (272)

Table 2: Administration frequency, systemic administered PTH.

Anabolic response on bone of PTH with administration frequency other than once daily. Included are known studies to our knowledge on regenerating bone and selected studies on remodelling bone. Mice models are excluded. Human PTH=hPTH. Model abbreviations: a) Regenerating bone: I=Implant related, F=Fracture, DO=Distraction osteogenesis, b) Non traumatised/remodelling bone: N=Non-pathological bone, L=low-density bone/osteoporotic bone/OVX/ORX

9. CORRIGENDA

Corrigenda generated 1st of February 2011. Corrections are related to clerical errors during the typing process of the PhD dissertation. Corrections have been added as an amendment to the published dissertation after the public defence / acceptance of the dissertation.

PhD Dissertation	Correction	Incorrect statement
Page 8, column 1. Cellular mechanism.	References are missing in the statement that intermittent PTH treatment increases osteoblast number: "Intermittent PTH treatment increases osteoblast number {Krishan, Mol Endocrinol, 2003; Lindsay, JBMR, 2006; Ma, JBMR, 2006; Iida-Klein, JBMR, 2002, Dobnig, Endocrinology, 1997; Bellido, J Biol Chem, 2003; Jilka J Clin Invest, 1999}"	"Intermittent PTH treatment increases osteoblast number."
Page 8, column 1. Cellular mechanism.	Missing statement. A section is missing in the description of the mechanism in osteoblast cell recruitment: "Recruitment of osteoblast cells by intermittent PTH treatment is suggested to be caused by the exit of osteoblast progenitors from the progenitor cell cycle or mesenchymal replication. However, results differ and only seem to concern regenerating bone {Dobnig, Endocrinology, 1995; Jilka, Bone, 2007, Pettway, Bone, 2008, Nakazawa, Bone, 2005}"	"Recruitment of osteoblast cells by intermittent PTH treatment is suggested to be caused by the exit of osteoblast progenitors from the progenitor cell cycle {Dobnig, Endocrinology, 1995; Jilka, Bone, 2007, Pettway, Bone, 2008}."
Page 12, column 2. Surgical technique.	Study III: Graft, Kirschner guide wire insertion. In study III (Graft study) The Kirschner-guide-wire was inserted 17 mm from the top of the major tubercle and not 1.7mm: "A 2.5 mm Kirschner-guide-wire was inserted anterolateral and perpendicular to the surface at a distance of 17 mm from the top of the major tubercle."	"A 2.5 mm Kirschner-guide-wire was inserted anterolateral and perpendicular to the surface at a distance of 1.7 mm from the top of the major tubercle."
Page 14, column 2. Sample size.	Sample size estimation calculation. The minimal relevant difference was 60%, not 80%: "The standard deviation (SD) was 50% and the minimal relevant difference (d) was set to 60%"	"The standard deviation (SD) was 50% and the minimal relevant difference (d) was set to 80%"
Page 15, column 2. Stereological bias.	Estimation of bias on implant model and sectioning technique: "The bias inherent in the used implant model and sectioning technique has been shown to be minimal {Baas, Acta Orthop Suppl, 2008}. The influence of the central section bias the systematic over- or underestimation in a mathematical model is 2-7%, and in a sample recount 1% {Baas, Acta Orthop Suppl, 2008}."	"The bias inherent in the used implant model and sectioning technique has been shown to be minimal {Baas, Acta Orthop Suppl, 2008}."
Page 16, column 2. ROI definition.	Maximum offset and minimum coverage. The stated maximum offset and minimum coverage are incorrect typed: "Under the assumption of an implant diameter of 6 mm, a maximum section offset from implant centre of 1.2 mm, and a reference space of 1000 µm, the minimum coverage on the section was 94 % (study I 93.8% and study II-III 93.4%)."	"Under the assumption of an implant diameter of 6 mm, a maximum section offset from implant centre of 1.3 mm and a reference space of 1000 µm, the minimum coverage on the section was 93 %."
Page 17, column 2. Mechanical testing setup.	Description on mechanical testing setup: "The specimens were placed on a metal support jig and the implant centred over a 7.4 mm circular opening assuring a 0,7 mm distance between the implant and support jig (clearance study I: 0.64 mm, study II: 0.60 mm, study III: 0,73 mm) (figure 11). The piston diameter was 5.25 mm and a preload of 2 N with a 5 second hold was applied. Implants were pushed from the external side towards the inside of the bone. With a displacement velocity of 5 mm/min and a 10kN load cell, continuous load (N) – displacement (mm) data were recorded by displacement control with sampling of the force needed to sustain the displacement rate. Data recorded every 20 µm."	"The specimens were placed on a metal support jig and the implant centred over a 7.4 mm circular opening assuring a 0,7 mm distance between the implant and support jig (figure 11). The piston diameter was 5.25 mm and a preload of 2 N with a 5 second hold was applied. Implants were pushed from the external side towards the inside of the bone. With a displacement velocity of 5 mm/min and a 10kN load cell, continuous load (N) – displacement (mm) data were recorded by displacement control."
Page 17, table 8.	Table 8 legend is incorrect. The table refers to study III, not study II: "Table 8. Reproducibility. Gap model (grafted gap)(study III), CV in percent."	"Table 8. Reproducibility. Gap model (grafted gap)(study II), CV in percent."
Page 18, figure 12.	In figure 12 the y-axis depicts stress and not strength: "y-axis: Stress (Pa)"	"y-axis: Strength (Pa)"
Page 19, column 1. Mechanical parameters generated.	Distance between points of sampling stiffness. The maximum shear stiffness (Pa/mm) was sampled as slope between 10 points with distance between each point 0.02mm. "The maximum shear stiffness (Pa/mm) was the maximum slope between 10 points successive sampled at testing (10 point slope ~ 0.2 mm)."	"The maximum shear stiffness (Pa/mm) was the maximum slope between 10 points successive sampled at testing (~0.03-0.04 mm)."
Page 19, column 1. Mechanical parameters evaluated.	Statement missing in discussion on strength and mechanical fixation: "Improving the mechanical fixation in terms of strength is in this respect less relevant. However, implant subsidence may reflect repetitive failures and implant reselling in the early phase of bone implant healing."	"Improving the mechanical fixation in terms of strength is in this respect less relevant."

10. REFERENCES

1. Laupacis A, Bourne R, Rorabeck C, Feeny D, Wong C, Tugwell P, et al. The effect of elective total hip replacement on health-related quality of life. *J Bone Joint Surg Am*. 1993 Nov;75(11):1619-26.
2. Gomez PF, Morcuende JA. Early attempts at hip arthroplasty-1700s to 1950s. *Iowa Orthop J*. 2005;25:25-9.
3. Hallab NJ, Jacobs JJ, J.L. K. *Biomaterials Science. An introduction to materials in medicine*. Ratner BD, Hoffman AS, Schoen FJ, Lemons JE, editors: Elsevier; 2004.
4. Smith-Petersen MN. Evolution of mould arthroplasty of the hip joint. 1948. *Clin Orthop Relat Res*. 2006 Dec;453:17-21.
5. Engh CA, Bobyn JD, Glassman AH. Porous-coated hip replacement. The factors governing bone ingrowth, stress shielding, and clinical results. *JBone Joint SurgBr*. 1987;69(1):45-55.
6. Charnley J. Arthroplasty of the hip. A new operation. *Lancet*. 1961 May 27;1(7187):1129-32.
7. Harris WH, Schiller AL, Scholler JM, Freiberg RA, Scott R. Extensive localized bone resorption in the femur following total hip replacement. *J Bone Joint Surg Am*. 1976 Jul;58(5):612-8.
8. Jones LC, Hungerford DS. Cement disease. *Clin Orthop Relat Res*. 1987 Dec(225):192-206.
9. Danish Hip Arthroplasty Register R. Annual report 2009. 2009.
10. Havelin LI, Engesaeter LB, Espehaug B, Furnes O, Lie SA, Vollset SE. The Norwegian Arthroplasty Register: 11 years and 73,000 arthroplasties. *Acta Orthop Scand*. 2000 Aug;71(4):337-53.
11. Emerson RH, Jr., Head WC, Emerson CB, Rosenfeldt W, Higgins LL. A comparison of cemented and cementless titanium femoral components used for primary total hip arthroplasty: a radiographic and survivorship study. *J Arthroplasty*. 2002 Aug;17(5):584-91.
12. Bourne RB, Rorabeck CH, Patterson JJ, Guerin J. Tapered titanium cementless total hip replacements: a 10- to 13-year followup study. *Clin Orthop Relat Res*. 2001 Dec(393):112-20.
13. Engh CA, Zettl-Schaffer KF, Kukita Y, Sweet D, Jasty M, Bragdon C. Histological and radiographic assessment of well functioning porous-coated acetabular components. A human postmortem retrieval study. *JBone Joint SurgAm*. 1993;75(6):814-24.
14. Johnsen SP, Sorensen HT, Lucht U, Soballe K, Overgaard S, Pedersen AB. Patient-related predictors of implant failure after primary total hip replacement in the initial, short- and long-terms. A nationwide Danish follow-up study including 36,984 patients. *J Bone Joint Surg Br*. 2006 Oct;88(10):1303-8.
15. Katz JL. Anisotropy of Young's modulus of bone. *Nature*. 1980 Jan 3;283(5742):106-7.
16. Katz JL. The structure and biomechanics of bone. *Symp Soc Exp Biol*. 1980;34:137-68.
17. Hofmann AA. Response of human cancellous bone to identically structured commercially pure titanium and cobalt chromium alloy porous-coated cylinders. *Clinical Materials*. 1993;14(2):101-15.
18. Long M, Rack HJ. Titanium alloys in total joint replacement--a materials science perspective. *Biomaterials*. 1998 Sep;19(18):1621-39.
19. Crowninshield R. An overview of prosthetic materials for fixation. *Clin Orthop Relat Res*. 1988 Oct(235):166-72.
20. Chang Y-S, GU H-O, Kobayashi M, Oka M. Influence of various structure treatments on histological fixation of titanium implants. *The Journal of Arthroplasty*. [Original]. 1998;13(7):816-25.
21. Goldberg VM, Stevenson S, Feighan J, Davy D. Biology of grit-blasted titanium alloy implants. *Clin OrthopRelat Res*. 1995(319):122-9.
22. Bobyn JD, Pilliar RM, Cameron HU, Weatherly GC. The optimum pore size for the fixation of porous-surfaced metal implants by the ingrowth of bone. *Clin OrthopRelat Res*. 1980(150):263-70.
23. Cook SD, Thomas KA, Haddad RJ, Jr. Histologic analysis of retrieved human porous-coated total joint components. *Clin OrthopRelat Res*. 1988(234):90-101.
24. Rahbek O, Overgaard S, Lind M, Bendix K, Bunger C, Soballe K. Sealing effect of hydroxyapatite coating on peri-implant migration of particles. An experimental study in dogs. *JBone Joint SurgBr*. 2001;83(3):441-7.
25. Pilliar RM, Lee JM, Maniopoulos C. Observations on the effect of movement on bone ingrowth into porous-surfaced implants. *Clin OrthopRelat Res*. 1986(208):108-13.
26. Jasty M, Bragdon C, Burke D, O'Connor D, Lowenstein J, Harris WH. In vivo skeletal responses to porous-surfaced implants subjected to small induced motions. *J Bone Joint SurgAm*. 1997;79(5):707-14.
27. Albrektsson TO, Johansson CB, Sennerby L. Biological aspects of implant dentistry: osseointegration. *Periodontol* 2000. 1994 Feb;4:58-73.
28. Ryd L. Roentgen stereophotogrammetric analysis of prosthetic fixation in the hip and knee joint. *Clin Orthop*. 1992(276):56-65.
29. Engh CA, Massin P, Suthers KE. Roentgenographic Assessment of the Biologic Fixation of Porous-Surfaced Femoral Components. *Clinical Orthopaedics and Related Research*. 1990(257):107-28.
30. Branemark PI, Hansson BO, Adell R, Breine U, Lindstrom J, Hallen O, et al. Osseointegrated implants in the treatment of the edentulous jaw. Experience from a 10-year period. *Scand J Plast Reconstr Surg Suppl*. 1977;16:1-132.
31. Albrektsson T, Branemark PI, Hansson HA, Lindstrom J. Osseointegrated titanium implants. Requirements for ensuring a long-lasting, direct bone-to-implant anchorage in man. *Acta Orthop Scand*. 1981;52(2):155-70.
32. Albrektsson T, Johansson C. Osteoinduction, osteoconduction and osseointegration. *European Spine Journal*. 2001 Oct;10:S96-S101.
33. Urist MR, Mikulski A, Lietze A. Solubilized and insolubilized bone morphogenetic protein. *Proc Natl Acad Sci U S A*. 1979 Apr;76(4):1828-32.
34. Lind M. Growth factors: possible new clinical tools. A review. *Acta Orthop Scand*. 1996 Aug;67(4):407-17.
35. Johansson CB, Han CH, Wennerberg A, Albrektsson T. A quantitative comparison of machined commercially pure titanium and titanium-aluminum-vanadium implants in rabbit bone. *Int J Oral Maxillofac Implants*. 1998 May-Jun;13(3):315-21.
36. Stefflik DE, Corpe RS, Lake FT, Young TR, Sisk AL, Parr GR, et al. Ultrastructural analyses of the attachment (bonding) zone between bone and implanted biomaterials. *J Biomed Mater Res*. 1998 Mar 15;39(4):611-20.
37. Deuel TF, Senior RM, Huang JS, Griffin GL. Chemotaxis of monocytes and neutrophils to platelet-derived growth factor. *J Clin Invest*. 1982 Apr;69(4):1046-9.

38. Matsuo M, Nakamura T, Kishi Y, Takahashi K. Microvascular changes after placement of titanium implants: scanning electron microscopy observations of machined and titanium plasma-sprayed implants in dogs. *J Periodontol.* 1999 Nov;70(11):1330-8.
39. Gruber R, Varga F, Fischer MB, Watzek G. Platelets stimulate proliferation of bone cells: involvement of platelet-derived growth factor, microparticles and membranes. *Clin Oral Implants Res.* 2002 Oct;13(5):529-35.
40. Bar-Shavit R, Kahn A, Wilner GD, Fenton JW, 2nd. Monocyte chemotaxis: stimulation by specific exosite region in thrombin. *Science.* 1983 May 13;220(4598):728-31.
41. Arnold F, West DC. Angiogenesis in wound healing. *Pharmacol Ther.* 1991 Dec;52(3):407-22.
42. Postlethwaite AE, Keski-Oja J, Moses HL, Kang AH. Stimulation of the chemotactic migration of human fibroblasts by transforming growth factor beta. *J Exp Med.* 1987 Jan 1;165(1):251-6.
43. Seppa H, Grotendorst G, Seppa S, Schiffmann E, Martin GR. Platelet-derived growth factor in chemotactic for fibroblasts. *J Cell Biol.* 1982 Feb;92(2):584-8.
44. Frost HM. The biology of fracture healing. An overview for clinicians. Part I. *Clin Orthop Relat Res.* 1989 Nov(248):283-93.
45. Frost HM. The biology of fracture healing. An overview for clinicians. Part II. *Clin Orthop.* 1989(248):294-309.
46. Young RW. Nucleic acids, protein synthesis and bone. *Clin Orthop Relat Res.* 1963;26:147-60.
47. Solheim E. Growth factors in bone. *Int Orthop.* 1998;22(6):410-6.
48. Graves DT, Valentin-Opran A, Delgado R, Valente AJ, Mundy G, Piche J. The potential role of platelet-derived growth factor as an autocrine or paracrine factor for human bone cells. *Connect Tissue Res.* 1989;23(2-3):209-18.
49. Tsukamoto T, Matsui T, Fukase M, Fujita T. Platelet-derived growth factor B chain homodimer enhances chemotaxis and DNA synthesis in normal osteoblast-like cells (MC3T3-E1). *Biochem Biophys Res Commun.* 1991 Mar 29;175(3):745-51.
50. Broberg M, Eriksson C, Nygren H. GPIIb/IIIa is the main receptor for initial platelet adhesion to glass and titanium surfaces in contact with whole blood. *Journal of Laboratory and Clinical Medicine.* 2002 Mar;139(3):163-72.
51. Park JY, Davies JE. Red blood cell and platelet interactions with titanium implant surfaces. *Clin Oral Implants Res.* 2000 Dec;11(6):530-9.
52. Nygren H, Eriksson C, Lausmaa J. Adhesion and activation of platelets and polymorphonuclear granulocyte cells at TiO₂ surfaces. *J Lab Clin Med.* 1997 Jan;129(1):35-46.
53. Kanagaraja S, Lundstrom I, Nygren H, Tengvall P. Platelet binding and protein adsorption to titanium and gold after short time exposure to heparinized plasma and whole blood. *Biomaterials.* 1996 Dec;17(23):2225-32.
54. Galbraith CG, Sheetz MP. A micromachined device provides a new bend on fibroblast traction forces. *Proc Natl Acad Sci U S A.* 1997 Aug 19;94(17):9114-8.
55. Davies JE. In vitro modeling of the bone/implant interface. *Anat Rec.* 1996 Jun;245(2):426-45.
56. Linder L, Albrektsson T, Branemark PI, Hansson HA, Ivarsson B, Jonsson U, et al. Electron microscopic analysis of the bone-titanium interface. *Acta OrthopScand.* 1983;54(1):45-52.
57. Ayukawa Y, Takeshita F, Inoue T, Yoshinari M, Shimono M, Suetsugu T, et al. An immunoelectron microscopic localization of noncollagenous bone proteins (osteocalcin and osteopontin) at the bone-titanium interface of rat tibiae. *J Biomed Mater Res.* 1998 Jul;41(1):111-9.
58. Puleo DA, Nanci A. Understanding and controlling the bone-implant interface. *Biomaterials.* 1999 Dec;20(23-24):2311-21.
59. Johansson C, Lausmaa J, Ask M, Hansson HA, Albrektsson T. Ultrastructural differences of the interface zone between bone and Ti 6Al 4V or commercially pure titanium. *J Biomed Eng.* 1989 Jan;11(1):3-8.
60. Roser K, Johansson CB, Donath K, Albrektsson T. A new approach to demonstrate cellular activity in bone formation adjacent to implants. *J Biomed Mater Res.* 2000 Aug;51(2):280-91.
61. Hofmann AA, Bloebaum RD, Bachus KN. Progression of human bone ingrowth into porous-coated implants. Rate of bone ingrowth in humans. *Acta Orthop Scand.* 1997 Apr;68(2):161-6.
62. Jasty M, Bragdon CR, Schutzer S, Rubash H, Haire T, Harris WH. Bone ingrowth into porous coated canine total hip replacements. Quantification by backscattered scanning electron microscopy and image analysis. *Scanning Microsc.* 1989 Dec;3(4):1051-6; discussion 6-7.
63. Soballe K, Hansen ES, Brockstedt-Rasmussen H, Pedersen CM, Bunger C. Hydroxyapatite coating enhances fixation of porous coated implants. A comparison in dogs between press fit and noninterference fit. *Acta OrthopScand.* 1990;61(4):299-306.
64. Engh CA, Hooten JP, Jr., Zettl-Schaffer KF, Ghaffarpour M, McGovern TF, Bobyn JD. Evaluation of bone ingrowth in proximally and extensively porous-coated anatomic medullary locking prostheses retrieved at autopsy. *J Bone Joint SurgAm.* 1995;77(6):903-10.
65. Pidhorz LE, Urban RM, Jacobs JJ, Sumner DR, Galante JO. A quantitative study of bone and soft tissues in cementless porous-coated acetabular components retrieved at autopsy. *J Arthroplasty.* 1993 Apr;8(2):213-25.
66. Urban RM, Jacobs JJ, Sumner DR, Peters CL, Voss FR, Galante JO. The bone-implant interface of femoral stems with non-circumferential porous coating. *J Bone Joint SurgAm.* 1996;78(7):1068-81.
67. Hastings DE, Parker SM. Protrusion acetabuli in rheumatoid arthritis. *Clin Orthop Relat Res.* 1975 May(108):76-83.
68. Slooff TJ, Huiskes R, van Horn J, Lemmens AJ. Bone grafting in total hip replacement for acetabular protrusion. *Acta Orthop Scand.* 1984 Dec;55(6):593-6.
69. Gie GA, Linder L, Ling RS, Simon JP, Slooff TJ, Timperley AJ. Impacted cancellous allografts and cement for revision total hip arthroplasty. *J Bone Joint Surg Br.* 1993 Jan;75(1):14-21.
70. Schreurs BW, Busch VJ, Welten ML, Verdonschot N, Slooff TJ, Gardeniers JW. Acetabular reconstruction with impaction bone-grafting and a cemented cup in patients younger than fifty years old. *J Bone Joint Surg Am.* 2004 Nov;86-A(11):2385-92.
71. Pekkarinen J, Alho A, Lepisto J, Ylikoski M, Ylinen P, Paavilainen T. Impaction bone grafting in revision hip surgery. A high incidence of complications. *J Bone Joint Surg Br.* 2000 Jan;82(1):103-7.
72. Eldridge JD, Smith EJ, Hubble MJ, Whitehouse SL, Learmonth ID. Massive early subsidence following femoral impaction grafting. *J Arthroplasty.* 1997 Aug;12(5):535-40.
73. Burchardt H. The biology of bone graft repair. *Clin Orthop Relat Res.* 1983 Apr(174):28-42.

74. Bauer TW, Muschler GF, editors. Bone graft materials - An overview of the basic science 1999 Apr 30-May 02; Washington, D.C.: Lippincott Williams & Wilkins.
75. Enneking WF, Mindell ER. Observations on massive retrieved human allografts. *J Bone Joint Surg Am.* 1991 Sep;73(8):1123-42.
76. Ullmark G, Nilsson O. Impacted corticocancellous allografts: recoil and strength. *J Arthroplasty.* 1999 Dec;14(8):1019-23.
77. Brodt MD, Swan CC, Brown TD. Mechanical behavior of human morselized cancellous bone in triaxial compression testing. *J Orthop Res.* 1998 Jan;16(1):43-9.
78. Ullmark G. Bigger size and defatting of bone chips will increase cup stability. *Arch Orthop Trauma Surg.* 2000;120(7-8):445-7.
79. Stevenson S. Enhancement of fracture healing with autogenous and allogeneic bone grafts. *Clin Orthop Relat Res.* 1998 Oct(355 Suppl):S239-46.
80. Aspenberg P, Tagil M, Kristensson C, Lidin S. Bone graft proteins influence osteoconduction - A titanium chamber study in rats. *Acta Orthopaedica Scandinavica.* 1996;67(4):377-82.
81. Ling RS, Timperley AJ, Linder L. Histology of cancellous impaction grafting in the femur. A case report. *J Bone Joint Surg Br.* 1993 Sep;75(5):693-6.
82. Nelissen RG, Bauer TW, Weidenhielm LR, LeGolvan DP, Mikhail WE. Revision hip arthroplasty with the use of cement and impaction grafting. Histological analysis of four cases. *J Bone Joint Surg Am.* 1995 Mar;77(3):412-22.
83. Heekin RD, Engh CA, Vinh T. Morselized allograft in acetabular reconstruction. A postmortem retrieval analysis. *Clin Orthop Relat Res.* 1995 Oct(319):184-90.
84. Buma P, Lamerigts N, Schreurs BW, Gardeniers J, Versleyen D, Slooff TJ. Impacted graft incorporation after cemented acetabular revision. Histological evaluation in 8 patients. *Acta Orthop Scand.* 1996 Dec;67(6):536-40.
85. Whiteside LA, Bicalho PS. Radiologic and histologic analysis of morselized allograft in revision total knee replacement. *Clin Orthop Relat Res.* 1998 Dec(357):149-56.
86. Tagil M. The morselized and impacted bone graft. Animal experiments on proteins, impaction and load 2000.
87. Ullmark G, Linder L. Histology of the femur after cancellous impaction grafting using a Charnley prosthesis. *Arch Orthop Trauma Surg.* 1998;117(3):170-2.
88. Tagil M, Jeppsson C, Aspenberg P. Bone graft incorporation - Effects of osteogenic protein-1 and impaction. *Clinical Orthopaedics and Related Research.* 2000(371):240-5.
89. Tagil M, Aspenberg P. Impaction of cancellous bone grafts impairs osteoconduction in titanium chambers. *Clinical Orthopaedics and Related Research.* 1998(352):231-8.
90. Wang JS, Tagil M, Aspenberg P. Load-bearing increases new bone formation in impacted and morselized allografts. *Clinical Orthopaedics and Related Research.* 2000(378):274-81.
91. Arnaud CD, Jr., Tenenhouse AM, Rasmussen H. Parathyroid hormone. *Annu Rev Physiol.* 1967;29:349-72.
92. Qin L, Raggatt LJ, Partridge NC. Parathyroid hormone: a double-edged sword for bone metabolism. *Trends Endocrinol Metab.* 2004 Mar;15(2):60-5.
93. Selye H. On the stimulation of new bone-formation with parathyroid extract and irradiated ergosterol. *Endocrinology.* 1932 Sep-Oct;16(5):547-58.
94. Tam CS, Heersche JN, Murray TM, Parsons JA. Parathyroid hormone stimulates the bone apposition rate independently of its resorptive action: differential effects of intermittent and continuous administration. *Endocrinology.* 1982 Feb;110(2):506-12.
95. Hock JM, Gera I. Effects of continuous and intermittent administration and inhibition of resorption on the anabolic response of bone to parathyroid hormone. *J Bone Miner Res.* 1992;7(1):65-72.
96. Pugsley LI. The effect of parathyroid hormone and of irradiated ergosterol on calcium and phosphorous metabolism in the rat. *J Physiol.* 1932 Nov 5;76(3):315-28.
97. Kalu DN, Doyle FH, Pennock J, Foster GV. Parathyroid hormone and experimental osteosclerosis. *Lancet.* 1970 Jun 27;1(7661):1363-6.
98. Potts JT, Jr., Tregear GW, Keutmann HT, Niall HD, Sauer R, Defetos LJ, et al. Synthesis of a biologically active N-terminal tetratriacontapeptide of parathyroid hormone. *Proc Natl Acad Sci U S A.* 1971 Jan;68(1):63-7.
99. Tregear GW, van Rietschoten J, Greene E, Niall HD, Keutmann HT, Parsons JA, et al. Solid-phase synthesis of the biologically active N-terminal 1 - 34 peptide of human parathyroid hormone. *Hoppe Seylers Z Physiol Chem.* 1974 Apr;355(4):415-21.
100. Reeve J, Hesp R, Williams D, Hulme P, Klenerman L, Zanelli JM, et al. Anabolic effect of low doses of a fragment of human parathyroid hormone on the skeleton in postmenopausal osteoporosis. *Lancet.* 1976 May 15;1(7968):1035-8.
101. Dempster DW, Cosman F, Parisien M, Shen V, Lindsay R. Anabolic actions of parathyroid hormone on bone. *Endocr Rev.* 1993;14(6):690-709.
102. Neer RM, Arnaud CD, Zanchetta JR, Prince R, Gaich GA, Reginster JY, et al. Effect of parathyroid hormone (1-34) on fractures and bone mineral density in postmenopausal women with osteoporosis. *NEngl J Med.* 2001;344(19):1434-41.
103. Kim HW, Jahng JS. Effect of intermittent administration of parathyroid hormone on fracture healing in ovariectomized rats. *Iowa OrthopJ.* 1999;19:71-7.
104. Andreassen TT, Ejersted C, Oxlund H. Intermittent parathyroid hormone (1-34) treatment increases callus formation and mechanical strength of healing rat fractures. *J Bone Miner Res.* 1999;14(6):960-8.
105. Aspenberg P, Genant HK, Johansson T, Nino AJ, See K, Krohn K, et al. Teriparatide for acceleration of fracture repair in humans: a prospective, randomized, double-blind study of 102 postmenopausal women with distal radial fractures. *J Bone Miner Res.* 2010 Feb;25(2):404-14.
106. Skripitz R, Andreassen TT, Aspenberg P. Parathyroid hormone (1-34) increases the density of rat cancellous bone in a bone chamber. A dose-response study. *Journal of Bone and Joint Surgery-British Volume.* 2000;82B(1):138-41.
107. Skripitz R, Andreassen TT, Aspenberg P. Strong effect of PTH (1-34) on regenerating bone: a time sequence study in rats. *Acta OrthopScand.* 2000;71(6):619-24.
108. Skripitz R, Aspenberg P. Early effect of parathyroid hormone (1-34) on implant fixation. *Clinical Orthopaedics and Related Research.* 2001(392):427-32.
109. Mosekilde L, Sogaard CH, Danielsen CC, Topping O. The anabolic effects of human parathyroid hormone (hPTH) on rat vertebral body mass are also reflected in the quality of bone, assessed by biomechanical testing: a comparison study between hPTH-(1-34) and hPTH-(1-84). *Endocrinology.* 1991;129(1):421-8.

110. Ejersted C, Andreassen TT, Oxlund H, Jorgensen PH, Bak B, Haggblad J, et al. Human parathyroid hormone (1-34) and (1-84) increase the mechanical strength and thickness of cortical bone in rats. *J Bone Miner Res.* 1993;8(9):1097-101.
111. Oxlund H, Ejersted C, Andreassen TT, Torring O, Nilsson MH. Parathyroid hormone (1-34) and (1-84) stimulate cortical bone formation both from periosteum and endosteum. *Calcif Tissue Int.* 1993;53(6):394-9.
112. Kimmel DB, Bozzato RP, Kronis KA, Coble T, Sindrey D, Kwong P, et al. The effect of recombinant human (1-84) or synthetic human (1-34) parathyroid hormone on the skeleton of adult osteopenic ovariectomized rats. *Endocrinology.* 1993;132(4):1577-84.
113. Whitfield JF, Morley P, Willick GE, Ross V, MacLean S, Barbier JR, et al. Comparison of the ability of recombinant human parathyroid hormone, rhPTH-(1-84), and hPTH-(1-31)NH2 to stimulate femoral trabecular bone growth in ovariectomized rats. *Calcif Tissue Int.* 1997;60(1):26-9.
114. Whitfield JF, Morley P, Willick GE, MacLean S, Ross V, Barbier J, et al. Stimulation of femoral trabecular bone growth in ovariectomized rats by human parathyroid hormone (hPTH)-(1-30)NH(2). *Calcif Tissue Int.* 1999;65(2):143-7.
115. Whitfield JF, Morley P. Small bone-building fragments of parathyroid hormone: new therapeutic agents for osteoporosis. *Trends Pharmacol Sci.* 1995 Nov;16(11):382-6.
116. ArmamentoVillareal R, Ziambaras K, AbbasJarhomi SH, Dimarogonas A, Halstead L, Fausto A, et al. An intact N terminus is required for the anabolic action of parathyroid hormone on adult female rats. *Journal of Bone and Mineral Research.* 1997 Mar;12(3):384-92.
117. Mohan S, Kutilek S, Zhang C, Shen HG, Kodama Y, Srivastava AK, et al. Comparison of bone formation responses to parathyroid hormone(1-34), (1-31), and (2-34) in mice. *Bone.* 2000 Oct;27(4):471-8.
118. High WB, Capen CC, Black HE. The effects of 1,25-dihydroxycholecalciferol, parathyroid hormone, and thyroxine on trabecular bone remodeling in adult dogs. A histomorphometric study. *Am J Pathol.* 1981;105(3):279-87.
119. Dobnig H, Turner RT. The effects of programmed administration of human parathyroid hormone fragment (1-34) on bone histomorphometry and serum chemistry in rats. *Endocrinology.* 1997 Nov;138(11):4607-12.
120. Rozen N, Lewinson D, Bick T, Jacob ZC, Stein H, Soudry M. Fracture repair: modulation of fracture-callus and mechanical properties by sequential application of IL-6 following PTH 1-34 or PTH 28-48. *Bone.* 2007 Sep;41(3):437-45.
121. Jung RE, Cochran DL, Domken O, Seibl R, Jones AA, Buser D, et al. The effect of matrix bound parathyroid hormone on bone regeneration. *Clin Oral Implants Res.* 2007 Jun;18(3):319-25.
122. Leone-Bay A, Sato M, Paton D, Hunt AH, Sarubbi D, Carozza M, et al. Oral delivery of biologically active parathyroid hormone. *Pharm Res.* 2001;18(7):964-70.
123. Podbesek R, Edouard C, Meunier PJ, Parsons JA, Reeve J, Stevenson RW, et al. Effects of two treatment regimes with synthetic human parathyroid hormone fragment on bone formation and the tissue balance of trabecular bone in greyhounds. *Endocrinology.* 1983;112(3):1000-6.
124. Frolik CA, Black EC, Cain RL, Satterwhite JH, Brown-Augsburger PL, Sato M, et al. Anabolic and catabolic bone effects of human parathyroid hormone (1-34) are predicted by duration of hormone exposure. *Bone.* 2003 Sep;33(3):372-9.
125. Bellido T, Ali AA, Gubrij I, Plotkin LI, Fu Q, O'Brien CA, et al. Chronic elevation of parathyroid hormone in mice reduces expression of sclerostin by osteocytes: a novel mechanism for hormonal control of osteoblastogenesis. *Endocrinology.* 2005 Nov;146(11):4577-83.
126. Lindsay R, Nieves J, Henneman E, Shen V, Cosman F. Subcutaneous administration of the amino-terminal fragment of human parathyroid hormone-(1-34): kinetics and biochemical response in estrogenized osteoporotic patients. *J Clin Endocrinol Metab.* 1993 Dec;77(6):1535-9.
127. Gabet Y, Muller R, Levy J, Dimarchi R, Chorev M, Bab I, et al. Parathyroid hormone 1-34 enhances titanium implant anchorage in low-density trabecular bone: a correlative micro-computed tomographic and biomechanical analysis. *Bone.* 2006 Aug;39(2):276-82.
128. Rubin MR, Cosman F, Lindsay R, Bilezikian JP. The anabolic effects of parathyroid hormone. *Osteoporos Int.* 2002;13(4):267-77.
129. Andreassen TT, Fledelius C, Ejersted C, Oxlund H. Increases in callus formation and mechanical strength of healing fractures in old rats treated with parathyroid hormone. *Acta Orthop Scand.* 2001;72(3):304-7.
130. Tashjian AH, Chabner BA. Commentary on clinical safety of recombinant human parathyroid hormone 1-34 in the treatment of osteoporosis in men and postmenopausal women. *Journal of Bone and Mineral Research.* 2002 Jul;17(7):1151-61.
131. Sietsema WK. Animal models of cortical porosity. *Bone.* 1995;17(4 Suppl):297S-305S.
132. Jerome CP, Johnson CS, Lees CJ. Effect of treatment for 3 months with human parathyroid-hormone 1-34 peptide in ovariectomized cynomolgus monkeys (*Macaca Fascicularis*). *Bone.* 1995 Feb 11-13:S415-S20.
133. Whitfield JF, Morley P, Willick G. The parathyroid hormone: an unexpected bone builder for treating osteoporosis: R.G. Landes Company; 1998.
134. Reeve J. PTH: a future role in the management of osteoporosis? *J Bone Miner Res.* 1996 Apr;11(4):440-5.
135. Ejersted C, Andreassen TT, Hauge EM, Melsen F, Oxlund H. Parathyroid hormone (1-34) increases vertebral bone mass, compressive strength, and quality in old rats. *Bone.* 1995;17(6):507-11.
136. Jerome CP. Anabolic effect of high doses of human parathyroid hormone (1-38) in mature intact female rats. *J Bone Miner Res.* 1994;9(6):933-42.
137. Mosekilde L, Sogaard CH, McOsker JE, Wronski TJ. PTH has a more pronounced effect on vertebral bone mass and biomechanical competence than antiresorptive agents (estrogen and bisphosphonate)--assessed in sexually mature, ovariectomized rats. *Bone.* 1994;15(4):401-8.
138. Nozaka K, Miyakoshi N, Kasukawa Y, Maekawa S, Noguchi H, Shimada Y. Intermittent administration of human parathyroid hormone enhances bone formation and union at the site of cancellous bone osteotomy in normal and ovariectomized rats. *Bone.* 2008 Jan;42(1):90-7.
139. Seebach C, Skripitz R, Andreassen TT, Aspenberg P. Intermittent parathyroid hormone (1-34) enhances mechanical strength and density of new bone after distraction osteogenesis in rats. *Journal of Orthopaedic Research.* 2004;22(3):472-8.

140. Lane NE, Thompson JM, Strewler GJ, Kinney JH. Intermittent treatment with human parathyroid hormone (hPTH[1-34]) increased trabecular bone volume but not connectivity in osteopenic rats. *J Bone Miner Res.* 1995;10(10):1470-7.
141. Hori M, Uzawa T, Morita K, Noda T, Takahashi H, Inoue J. Effect of human parathyroid hormone (PTH(1-34)) on experimental osteopenia of rats induced by ovariectomy. *Bone Miner.* 1988;3(3):193-9.
142. Shen V, Dempster DW, Mellish RW, Birchman R, Horbert W, Lindsay R. Effects of combined and separate intermittent administration of low-dose human parathyroid hormone fragment (1-34) and 17 beta-estradiol on bone histomorphometry in ovariectomized rats with established osteopenia. *Calcif Tissue Int.* 1992;50(3):214-20.
143. Hirano T, Burr DB, Turner CH, Sato M, Cain RL, Hock JM. Anabolic effects of human biosynthetic parathyroid hormone fragment (1-34), LY333334, on remodeling and mechanical properties of cortical bone in rabbits. *J Bone Miner Res.* 1999;14(4):536-45.
144. Brommage R, Hotchkiss CE, Lees CJ, Stancill MW, Hock JM, Jerome CP. Daily treatment with human recombinant parathyroid hormone-(1-34), LY333334, for 1 year increases bone mass in ovariectomized monkeys. *J Clin Endocrinol Metab.* 1999;84(10):3757-63.
145. Fox J, Newman MK, Turner CH, Guldborg RE, Varela A, Smith SY. Effects of treatment with parathyroid hormone 1-84 on quantity and biomechanical properties of thoracic vertebral trabecular bone in ovariectomized rhesus monkeys. *Calcif Tissue Int.* 2008 Mar;82(3):212-20.
146. Zhang L, Takahashi HE, Tanizawa T, Endo N, Yamamoto N, Hori M. Low dose of human PTH(1-34) improved tibial subcortical bone mass without further cortical bone loss in adult intact beagles. *Journal of Bone and Mineral Metabolism.* 1998;16(2):96-9.
147. Inoue J, Takahashi H, Konno T. Histomorphometric evaluation on Ilium of beagle dogs with long-term administration of low-dose 1-34 PTH. *Bone.* [Meeting Abstract]. 1985;6(5):401-.
148. Zhang L, Takahashi HE, Inoue J, Tanizawa T, Endo N, Yamamoto N, et al. Effects of intermittent administration of low dose human PTH(1-34) on cancellous and cortical bone of lumbar vertebral bodies in adult beagles. *Bone.* 1997;21(6):501-6.
149. Boyce RW, Paddock CL, Franks AF, Jankowsky ML, Eriksen EF. Effects of intermittent hPTH(1-34) alone and in combination with 1,25(OH)(2)D(3) or risedronate on endosteal bone remodeling in canine cancellous and cortical bone. *J Bone Miner Res.* 1996;11(5):600-13.
150. Ma YF, Chen YY, Ijiri K, et al. PTH in combination with risedronate in aged beagle dogs resulted in bone balance similar to PTH alone. *Bone.* 1997;20(99S):99.
151. Jahng JS, Kim HW. Effect of intermittent administration of parathyroid hormone on fracture healing in ovariectomized rats. *Orthopedics.* 2000;23(10):1089-94.
152. Alkhiary YM, Gerstenfeld LC, Krall E, Westmore M, Sato M, Mitlak BH, et al. Enhancement of experimental fracture-healing by systemic administration of recombinant human parathyroid hormone (PTH 1-34). *J Bone Joint Surg Am.* 2005 Apr;87(4):731-41.
153. Morgan EF, Mason ZD, Bishop G, Davis AD, Wigner NA, Gerstenfeld LC, et al. Combined effects of recombinant human BMP-7 (rhBMP-7) and parathyroid hormone (1-34) in metaphyseal bone healing. *Bone.* 2008 Aug 9;43(6):1031-8.
154. Nakazawa T, Nakajima A, Shiomi K, Moriya H, Einhorn TA, Yamazaki M. Effects of low-dose, intermittent treatment with recombinant human parathyroid hormone (1-34) on chondrogenesis in a model of experimental fracture healing. *Bone.* 2005 Nov;37(5):711-9.
155. Nakajima A, Shimoji N, Shiomi K, Shimizu S, Moriya H, Einhorn TA, et al. Mechanisms for the enhancement of fracture healing in rats treated with intermittent low-dose human parathyroid hormone (1-34). *J Bone Miner Res.* 2002;17(11):2038-47.
156. Sloan AV, Martin JR, Li S, Li J. Parathyroid hormone and bisphosphonate have opposite effects on stress fracture repair. *Bone.* 2010 Aug;47(2):235-40.
157. Andreassen TT, Willick GE, Morley P, Whitfield JF. Treatment with Parathyroid Hormone hPTH(1-34), hPTH(1-31), and Monocyclic hPTH(1-31) Enhances Fracture Strength and Callus Amount After Withdrawal Fracture Strength and Callus Mechanical Quality Continue to Increase. *Calcif Tissue Int.* 2004.
158. Holzer G, Majeska RJ, Lundy MW, Hartke JR, Einhorn TA. Parathyroid hormone enhances fracture healing. A preliminary report. *Clin Orthop Relat Res.* 1999(366):258-63.
159. Tagil M, McDonald MM, Morse A, Peacock L, Mikulec K, Amanat N, et al. Intermittent PTH((1-34)) does not increase union rates in open rat femoral fractures and exhibits attenuated anabolic effects compared to closed fractures. *Bone.* 2010 Mar;46(3):852-9.
160. Tsiridis E, Morgan EF, Bancroft JM, Song M, Kain M, Gerstenfeld L, et al. Effects of OP-1 and PTH in a new experimental model for the study of metaphyseal bone healing. *J Orthop Res.* 2007 Sep;25(9):1193-203.
161. Aspenberg P, Genant HK, Johansson T, Nino AJ, See K, Krohn K, et al. Teriparatide for Acceleration of Fracture Repair in Humans: A Prospective, Randomized, Double-blind Study of 102 Postmenopausal Women with Distal Radial Fractures. *J Bone Miner Res.* 2009 Jul 13.
162. Komatsubara S, Mori S, Mashiba T, Nonaka K, Seki A, Akiyama T, et al. Human parathyroid hormone (1-34) accelerates the fracture healing process of woven to lamellar bone replacement and new cortical shell formation in rat femora. *Bone.* 2005 Apr;36(4):678-87.
163. Manabe T, Mori S, Mashiba T, Kaji Y, Iwata K, Komatsubara S, et al. Human parathyroid hormone (1-34) accelerates natural fracture healing process in the femoral osteotomy model of cynomolgus monkeys. *Bone.* 2007 Jun;40(6):1475-82.
164. Corsini MS, Faraco FN, Castro AA, Onuma T, Sendyk WR, Shibli JA. Effect of systemic intermittent administration of human parathyroid hormone (rhPTH[1-34]) on the resistance to reverse torque in rabbit tibiae. *J Oral Implantol.* 2008;34(6):298-302.
165. Skripitz R, Johansson HR, Ulrich SD, Werner A, Aspenberg P. Effect of alendronate and intermittent parathyroid hormone on implant fixation in ovariectomized rats. *J Orthop Sci.* 2009 Mar;14(2):138-43.
166. Skripitz R, Aspenberg P. Parathyroid hormone (1-34) increases attachment of PMMA cement to bone. *J Orthop Sci.* 2001;6(6):540-4.
167. Skripitz R, Aspenberg P. Implant fixation enhanced by intermittent treatment with parathyroid hormone. *J Bone Joint Surg Br.* 2001;83(3):437-40.
168. Dayer R, Brennan TC, Rizzoli R, Ammann P. PTH improves titanium implant fixation more than pamidronate or

- renutrition in osteopenic rats chronically fed a low protein diet. *Osteoporos Int.* 2010 Jun;21(6):957-67.
169. Gabet Y, Kohavi D, Voide R, Mueller TL, Muller R, Bab I. Endosseous Implant Anchorage is Critically Dependent on Mechanical Determinants of Peri-Implant Bone Trabeculae. *J Bone Miner Res.* 2009 Aug 4.
 170. Ohkawa Y, Tokunaga K, Endo N. Intermittent administration of human parathyroid hormone (1-34) increases new bone formation on the interface of hydroxyapatite-coated titanium rods implanted into ovariectomized rat femora. *J Orthop Sci. [Article].* 2008 Nov;13(6):533-42.
 171. Shirota T, Tashiro M, Ohno K, Yamaguchi A. Effect of intermittent parathyroid hormone (1-34) treatment on the bone response after placement of titanium implants into the tibia of ovariectomized rats. *J Oral Maxillofac Surg.* 2003;61(4):471-80.
 172. Skripitz R, Bohling S, Ruther W, Aspenberg P. Stimulation of implant fixation by parathyroid hormone (1-34)-A histomorphometric comparison of PMMA cement and stainless steel. *J Orthop Res.* 2005 Nov;23(6):1266-70.
 173. Mair B, Tangl S, Feierfeil J, Skiba D, Watzek G, Gruber R. Age-related efficacy of parathyroid hormone on osseointegration in the rat. *Clin Oral Implants Res.* 2009 Apr;20(4):400-5.
 174. Dayer R, Badoud I, Rizzoli R, Ammann P. Defective implant osseointegration under protein undernutrition: Prevention by PTH or pamidronate. *Journal of Bone and Mineral Research.* 2007 Oct;22(10):1526-33.
 175. Kamo K, Miyakoshi N, Kasukawa Y, Nozaka K, Sasaki H, Shimada Y. Intermittent weekly administration of human parathyroid hormone (1-34) improves bone-hydroxyapatite block bonding in ovariectomized rats. *J Bone Miner Metab.* 2010 Apr 8.
 176. Aleksyniene R, Eckardt H, Bundgaard K, Lind M, Hvid I. Effects of parathyroid hormone on newly regenerated bone during distraction osteogenesis in a rabbit tibial lengthening model. A pilot study. *Medicina (Kaunas).* 2006;42(1):38-48.
 177. Aleksyniene R, Thomsen JS, Eckardt H, Bundgaard KG, Lind M, Hvid I. Three-dimensional microstructural properties of regenerated mineralizing tissue after PTH (1-34) treatment in a rabbit tibial lengthening model. *J Musculoskelet Neuronal Interact.* 2009 Oct-Dec;9(4):268-77.
 178. Riond JL. Modulation of the anabolic effect of synthetic human parathyroid hormone fragment-(1-34) in the bone of growing rats by variations in the dosage regimen. *Clin Sci (Lond).* 1993;85(2):223-8.
 179. Dobnig H, Turner RT. Evidence that intermittent treatment with parathyroid hormone increases bone formation in adult rats by activation of bone lining cells. *Endocrinology.* 1995;136(8):3632-8.
 180. Li M, Liang H, Shen Y, Wronski TJ. Parathyroid hormone stimulates cancellous bone formation at skeletal sites regardless of marrow composition in ovariectomized rats. *Bone.* 1999;24(2):95-100.
 181. Watson PH, Fraher LJ, Kiesel M, DeSousa D, Hendy G, Hodsman AB. Enhanced osteoblast development after continuous infusion of hPTH(1-84) in the rat. *Bone.* 1999;24(2):89-94.
 182. Kakar S, Einhorn TA, Vora S, Miara LJ, Hon G, Wigner NA, et al. Enhanced chondrogenesis and Wnt signaling in PTH-treated fractures. *Journal of Bone and Mineral Research. [Article].* 2007 Dec;22(12):1903-12.
 183. Li G, Dickson GR, Marsh DR, Simpson H. Rapid new bone tissue remodeling during distraction osteogenesis is associated with apoptosis. *J Orthop Res.* 2003 Jan;21(1):28-35.
 184. Whitfield JF, Morley P, Willick GE, Ross V, Barbier JR, Isaacs RJ, et al. Stimulation of the growth of femoral trabecular bone in ovariectomized rats by the novel parathyroid hormone fragment, hPTH-(1-31)NH₂ (Ostabolin). *Calcif Tissue Int.* 1996 Feb;58(2):81-7.
 185. Armamento-Villareal R, Ziambaras K, bbasi-Jarhomi SH, Dimarogonas A, Halstead L, Fausto A, et al. An intact N terminus is required for the anabolic action of parathyroid hormone on adult female rats. *J Bone Miner Res.* 1997;12(3):384-92.
 186. Krishnan V, Moore TL, Ma YL, Helvering LM, Frolik CA, Valasek KM, et al. Parathyroid hormone bone anabolic action requires Cbfa1/Runx2-dependent signaling. *Mol Endocrinol.* 2003 Mar;17(3):423-35.
 187. Jilka RL. Molecular and cellular mechanisms of the anabolic effect of intermittent PTH. *Bone. [Review].* 2007 Jun;40(6):1434-46.
 188. Bilezikian JP, Raisz LG, Rodan GA. *Principles of Bone Biology* 2002.
 189. Leupin O, Kramer I, Collette NM, Loots GG, Natt F, Kneissel M, et al. Control of the SOST bone enhancer by PTH using MEF2 transcription factors. *J Bone Miner Res.* 2007 Dec;22(12):1957-67.
 190. Almeida M, Han L, Bellido T, Manolagas SC, Kousteni S. Wnt proteins prevent apoptosis of both uncommitted osteoblast progenitors and differentiated osteoblasts by beta-catenin-dependent and -independent signaling cascades involving Src/ERK and phosphatidylinositol 3-kinase/AKT. *J Biol Chem.* 2005 Dec 16;280(50):41342-51.
 191. Krishnan V, Bryant HU, Macdougald OA. Regulation of bone mass by Wnt signaling. *J Clin Invest.* 2006 May;116(5):1202-9.
 192. Potter LK, Greller LD, Cho CR, Nuttall ME, Stroup GB, Suva LJ, et al. Response to continuous and pulsatile PTH dosing: a mathematical model for parathyroid hormone receptor kinetics. *Bone.* 2005 Aug;37(2):159-69.
 193. Onyia JE, Helvering LM, Gelbert L, Wei T, Huang S, Chen P, et al. Molecular profile of catabolic versus anabolic treatment regimens of parathyroid hormone (PTH) in rat bone: an analysis by DNA microarray. *J Cell Biochem.* 2005 May 15;95(2):403-18.
 194. Locklin RM, Khosla S, Turner RT, Riggs BL. Mediators of the biphasic responses of bone to intermittent and continuously administered parathyroid hormone. *J Cell Biochem.* 2003 May 1;89(1):180-90.
 195. Pettway GJ, Meganck JA, Koh AJ, Keller ET, Goldstein SA, McCauley LK. Parathyroid hormone mediates bone growth through the regulation of osteoblast proliferation and differentiation. *Bone.* 2008 Apr;42(4):806-18.
 196. Bellido T, Ali AA, Plotkin LI, Fu Q, Gubrij I, Roberson PK, et al. Proteasomal degradation of Runx2 shortens parathyroid hormone-induced anti-apoptotic signaling in osteoblasts. A putative explanation for why intermittent administration is needed for bone anabolism. *J Biol Chem.* 2003 Dec 12;278(50):50259-72.
 197. Lindsay R, Zhou H, Cosman F, Nieves J, Dempster DW, Hodsman AB. Effects of a one-month treatment with PTH(1-34) on bone formation on cancellous, endocortical, and periosteal surfaces of the human ilium. *Journal of Bone and Mineral Research.* 2007 Apr;22(4):495-502.

198. Leaffer D, Sweeney M, Kellerman LA, Avnur Z, Krstenansky JL, Vickery BH, et al. Modulation of osteogenic cell ultrastructure by RS-23581, an analog of human parathyroid hormone (PTH)-related peptide-(1-34), and bovine PTH-(1-34). *Endocrinology*. 1995;136(8):3624-31.
199. Nishida S, Yamaguchi A, Tanizawa T, Endo N, Mashiba T, Uchiyama Y, et al. Increased bone formation by intermittent parathyroid hormone administration is due to the stimulation of proliferation and differentiation of osteoprogenitor cells in bone marrow. *Bone*. 1994;15(6):717-23.
200. Onyia JE, Bidwell J, Herring J, Hulman J, Hock JM. In vivo, human parathyroid hormone fragment (hPTH 1-34) transiently stimulates immediate early response gene expression, but not proliferation, in trabecular bone cells of young rats. *Bone*. 1995;17(5):479-84.
201. Skripitz R. Parathyroid hormone for bone repair and implant fixation. Experiments in rats. Lund, Sweden 2001.
202. Kaback LA, Soung do Y, Naik A, Geneau G, Schwarz EM, Rosier RN, et al. Teriparatide (1-34 human PTH) regulation of osterix during fracture repair. *J Cell Biochem*. 2008 Sep 1;105(1):219-26.
203. Li M, Wronski TJ. Response of femoral neck to estrogen depletion and parathyroid hormone in aged rats. *Bone*. 1995;16(5):551-7.
204. O'Loughlin PF, Cunningham ME, Bukata SV, Tomin E, Poynton AR, Doty SB, et al. Parathyroid hormone (1-34) augments spinal fusion, fusion mass volume, and fusion mass quality in a rabbit spinal fusion model. *Spine*. 2009 Jan 15;34(2):121-30.
205. Jerome CP, Johnson CS, Vafai HT, Kaplan KC, Bailey J, Capwell B, et al. Effect of treatment for 6 months with human parathyroid hormone (1-34) peptide in ovariectomized cynomolgus monkeys (*Macaca fascicularis*). *Bone*. 1999;25(3):301-9.
206. Sato M, Westmore M, Ma YL, Schmidt A, Zeng QQ, Glass EV, et al. Teriparatide [PTH(1-34)] strengthens the proximal femur of ovariectomized nonhuman primates despite increasing porosity. *J Bone Miner Res*. 2004;19(4):623-9.
207. Fox J, Miller MA, Recker RR, Turner CH, Smith SY. Effects of treatment of ovariectomized adult rhesus monkeys with parathyroid hormone 1-84 for 16 months on trabecular and cortical bone structure and biomechanical properties of the proximal femur. *Calcif Tissue Int*. 2007 Jul;81(1):53-63.
208. Oxlund H, Dalstra M, Ejersted C, Andreassen TT. Parathyroid hormone induces formation of new cancellous bone with substantial mechanical strength at a site where it had disappeared in old rats. *Eur J Endocrinol*. 2002;146(3):431-8.
209. Ejersted C, Andreassen TT, Nilsson MH, Oxlund H. Human parathyroid hormone(1-34) increases bone formation and strength of cortical bone in aged rats. *Eur J Endocrinol*. 1994;130(2):201-7.
210. Dempster DW, Cosman F, Kurland ES, Zhou H, Nieves J, Woelfert L, et al. Effects of daily treatment with parathyroid hormone on bone microarchitecture and turnover in patients with osteoporosis: a paired biopsy study. *J Bone Miner Res*. 2001 Oct;16(10):1846-53.
211. Jiang Y, Zhao JJ, Mitlak BH, Wang O, Genant HK, Eriksen EF. Recombinant human parathyroid hormone (1-34) [teriparatide] improves both cortical and cancellous bone structure. *J Bone Miner Res*. 2003 Nov;18(11):1932-41.
212. Ma YL, Zeng Q, Donley DW, Ste-Marie LG, Gallagher JC, Dalsky GP, et al. Teriparatide increases bone formation in modeling and remodeling osteons and enhances IGF-II immunoreactivity in postmenopausal women with osteoporosis. *J Bone Miner Res*. 2006 Jun;21(6):855-64.
213. Andreassen TT, Oxlund H. The influence of combined parathyroid hormone and growth hormone treatment on cortical bone in aged ovariectomized rats. *J Bone Miner Res*. 2000;15(11):2266-75.
214. Jung RE, Hammerle CH, Kokovic V, Weber FE. Bone regeneration using a synthetic matrix containing a parathyroid hormone peptide combined with a grafting material. *Int J Oral Maxillofac Implants*. 2007 Mar-Apr;22(2):258-66.
215. Jerome CP, Burr DB, Van BT, Hock JM, Brommage R. Treatment with human parathyroid hormone (1-34) for 18 months increases cancellous bone volume and improves trabecular architecture in ovariectomized cynomolgus monkeys (*Macaca fascicularis*). *Bone*. 2001;28(2):150-9.
216. Hodsman AB, Fraher LJ, Watson PH, Ostbye T, Stitt LW, Adachi JD, et al. A randomized controlled trial to compare the efficacy of cyclical parathyroid hormone versus cyclical parathyroid hormone and sequential calcitonin to improve bone mass in postmenopausal women with osteoporosis. *J Clin Endocrinol Metab*. 1997;82(2):620-8.
217. Cosman F, Lindsay R. Is parathyroid hormone a therapeutic option for osteoporosis? A review of the clinical evidence. *Calcif Tissue Int*. 1998;62(6):475-80.
218. Kishi T, Hagino H, Kishimoto H, Nagashima H. Bone responses at various skeletal sites to human parathyroid hormone in ovariectomized rats: effects of long-term administration, withdrawal, and readministration. *Bone*. 1998 May;22(5):515-22.
219. Iida-Klein A, Zhou H, Lu SS, Levine LR, Ducayen-Knowles M, Dempster DW, et al. Anabolic action of parathyroid hormone is skeletal site specific at the tissue and cellular levels in mice. *J Bone Miner Res*. 2002 May;17(5):808-16.
220. Sogaard CH, Wronski TJ, McOsker JE, Mosekilde L. The positive effect of parathyroid hormone on femoral neck bone strength in ovariectomized rats is more pronounced than that of estrogen or bisphosphonates. *Endocrinology*. 1994;134(2):650-7.
221. Jilka RL, O'Brien CA, Ali AA, Roberson PK, Weinstein RS, Manolagas SC. Intermittent PTH stimulates periosteal bone formation by actions on post-mitotic preosteoblasts. *Bone*. 2009 Feb;44(2):275-86.
222. Halloran BP, Bikle DD, Harris J, Tanner S, Curren T, Morey-Holton E. Regional responsiveness of the tibia to intermittent administration of parathyroid hormone as affected by skeletal unloading. *J Bone Miner Res*. 1997 Jul;12(7):1068-74.
223. Zhang L, Takahashi HE, Inoue J, Tanizawa T, Endo N, Yamamoto N, et al. Low dose human PTH(1-34) improved axial subcortical bone mass without further cortical bone loss in adult beagle. *Journal of Bone and Mineral Research*. 1997 Aug;12:T531-T.
224. Johansson HR, Skripitz R, Aspenberg P. Bisphosphonates can block the deterioration in implant fixation after withdrawal of intermittent doses of parathyroid hormone. *J Bone Joint Surg Br*. 2008 Mar;90(3):400-4.
225. Sumner DR, Turner TM, Urban RM. Animal models relevant to cementless joint replacement. *J Musculoskelet Neuronal Interact*. 2001 Jun;1(4):333-45.
226. Vestergaard P, Rejnmark L, Mosekilde L. [Osteoporosis and fractures associated with drugs]. *Ugeskr Laeger*. 2007;170(18):1550-5.

227. Eitel F, Klapp F, Jacobson W, Schweiberer L. Bone regeneration in animals and in man. A contribution to understanding the relative value of animal experiments to human pathophysiology. *ArchOrthopTrauma Surg*. 1981;99(1):59-64.
228. Aerssens J, Boonen S, Lowet G, Dequeker J. Interspecies differences in bone composition, density, and quality: potential implications for in vivo bone research. *Endocrinology*. 1998;139(2):663-70.
229. Soballe K. Hydroxyapatite ceramic coating for bone implant fixation. Mechanical and histological studies in dogs. *Acta OrthopScandSuppl*. 1993;255:1-58.
230. Kimmel DB, Jee WS. A quantitative histologic study of bone turnover in young adult beagles. *Anat Rec*. 1982 May;203(1):31-45.
231. Soballe K, Hansen ES, Brockstedt-Rasmussen H, Pedersen CM, Bunger C. Bone graft incorporation around titanium-alloy- and hydroxyapatite-coated implants in dogs. *ClinOrthop*. 1992(274):282-93.
232. Lind M, Overgaard S, Jensen TB, Song Y, Goodman SB, Bunger C, et al. Effect of osteogenic protein 1/collagen composite combined with impacted allograft around hydroxyapatite-coated titanium alloy implants is moderate. *JBiomedMaterRes*. 2001;55(1):89-95.
233. Horwitz MJ, Tedesco MB, Sereika SM, Hollis BW, Garcia-Ocana A, Stewart AF. Direct comparison of sustained infusion of human parathyroid hormone-related protein-(1-36) [hPTHrP-(1-36)] versus hPTH-(1-34) on serum calcium, plasma 1,25-dihydroxyvitamin D concentrations, and fractional calcium excretion in healthy human volunteers. *J Clin Endocrinol Metab*. 2003 Apr;88(4):1603-9.
234. Podbesek RD, Mawer EB, Zanelli GD, Parsons JA, Reeve J. Intestinal absorption of calcium in greyhounds: the response to intermittent and continuous administration of human synthetic parathyroid hormone fragment 1-34 (hPTH 1-34). *Clin Sci (Lond)*. 1984;67(6):591-9.
235. Pallesen L, Schou S, Aaboe M, Hjorting-Hansen E, Nattestad A, Melsen F. Influence of particle size of autogenous bone grafts on the early stages of bone regeneration: a histologic and stereologic study in rabbit calvarium. *Int J Oral Maxillofac Implants*. 2002 Jul-Aug;17(4):498-506.
236. Johansen K. Basal sundhedsvidenskabelig statistik. 1 ed: Munksgaard Danmark; 2002.
237. Gotfredsen K, Budtz-Jorgensen E, Jensen LN. A method for preparing and staining histological sections containing titanium implants for light microscopy. *Stain Technol*. 1989;64(3):121-7.
238. Overgaard S, Bromose U, Lind M, Bunger C, Soballe K. The influence of crystallinity of the hydroxyapatite coating on the fixation of implants. Mechanical and histomorphometric results. *J Bone Joint SurgBr*. 1999;81(4):725-31.
239. Overgaard S, Soballe K, Jorgen H, Gundersen G. Efficiency of systematic sampling in histomorphometric bone research illustrated by hydroxyapatite-coated implants: optimizing the stereological vertical-section design. *J OrthopRes*. 2000;18(2):313-21.
240. Keaveny TM, Morgan EF, Niebur GL, Yeh OC. Biomechanics of trabecular bone. *Annu Rev Biomed Eng*. 2001;3:307-33.
241. Mosekilde L, Viidik A. Correlation between the compressive strength of iliac and vertebral trabecular bone in normal individuals. *Bone*. 1985;6(5):291-5.
242. Baddeley AJ, Gundersen HJ, Cruz-Orive LM. Estimation of surface area from vertical sections. *JMicrosc*. 1986;142 (Pt 3):259-76.
243. Vesterby A, Kragstrup J, Gundersen HJ, Melsen F. Unbiased stereologic estimation of surface density in bone using vertical sections. *Bone*. 1987;8(1):13-7.
244. Baas J. Adjuvant therapies of bone graft around non-cemented experimental orthopedic implants stereological methods and experiments in dogs. *Acta Orthop Suppl*. 2008 Aug;79(330):1-43.
245. Harrigan TP, Kareh J, Harris WH. The influence of support conditions in the loading fixture on failure mechanisms in the push-out test: a finite element study. *JOrthopRes*. 1990;8(5):678-84.
246. Shirazi-Adl A. Finite element stress analysis of a push-out test. Part 1: Fixed interface using stress compatible elements. *J Biomech Eng*. 1992 Feb;114(1):111-8.
247. Dhert WJ, Verheyen CC, Braak LH, de W, Jr., Klein CP, de GK, et al. A finite element analysis of the push-out test: influence of test conditions. *JBiomedMaterRes*. 1992;26(1):119-30.
248. Ciarelli TE, Fyhrie DP, Schaffler MB, Goldstein SA. Variations in three-dimensional cancellous bone architecture of the proximal femur in female hip fractures and in controls. *J Bone Miner Res*. 2000 Jan;15(1):32-40.
249. Mosekilde L. Iliac crest trabecular bone volume as predictor for vertebral compressive strength, ash density and trabecular bone volume in normal individuals. *Bone*. 1988;9(4):195-9.
250. Amling M, Herden S, Posl M, Hahn M, Ritzel H, Delling G. Heterogeneity of the skeleton: comparison of the trabecular microarchitecture of the spine, the iliac crest, the femur, and the calcaneus. *J Bone Miner Res*. 1996 Jan;11(1):36-45.
251. Dalton JE, Cook SD. Influence of implant location on the mechanical characteristics using the transcortical model. *J Biomed Mater Res*. 1995 Jan;29(1):133-6.
252. Shirazi-Adl A, Forcione A. Finite element stress analysis of a push-out test. Part II: Free interface with nonlinear friction properties. *J Biomech Eng*. 1992 May;114(2):155-61.
253. Linde F. Elastic and viscoelastic properties of trabecular bone by a compression testing approach. *Dan Med Bull*. 1994 Apr;41(2):119-38.
254. Carter DR, Hayes WC. The compressive behavior of bone as a two-phase porous structure. *JBone Joint SurgAm*. 1977;59(7):954-62.
255. Carter DR, Hayes WC. Bone compressive strength: the influence of density and strain rate. *Science*. 1976;194(4270):1174-6.
256. Linde F, Sorensen HC. The effect of different storage methods on the mechanical properties of trabecular bone. *J Biomech*. 1993;26(10):1249-52.
257. Yamashita J, Li X, Furman BR, Rawls HR, Wang X, Agrawal CM. Collagen and bone viscoelasticity: a dynamic mechanical analysis. *J Biomed Mater Res*. 2002;63(1):31-6.
258. Currey JD. The mechanical consequences of variation in the mineral content of bone. *J Biomech*. 1969 Mar;2(1):1-11.
259. Gupta HS, Seto J, Wagermaier W, Zaslansky P, Boesecke P, Fratzl P. Cooperative deformation of mineral and collagen in bone at the nanoscale. *Proc Natl Acad Sci U S A*. 2006 Nov 21;103(47):17741-6.
260. Fantner GE, Hassenkam T, Kindt JH, Weaver JC, Birkedal H, Pechenik L, et al. Sacrificial bonds and hidden length dissipate energy as mineralized fibrils separate during bone fracture. *Nat Mater*. 2005 Aug;4(8):612-6.

261. Ingham E, Fisher J. Biological reactions to wear debris in total joint replacement. *ProclnstMechEng [H]*. 2000;214(1):21-37.
262. Elmengaard B, Bechtold JE, Soballe K. In vivo study of the effect of RGD treatment on bone ongrowth on press-fit titanium alloy implants. *Biomaterials*. 2005;26(17):3521-6.
263. Daugaard H, Elmengaard B, Bechtold JE, Soballe K. Bone growth enhancement in vivo on press-fit titanium alloy implants with acid etched microtexture. *J Biomed Mater Res A*. 2008;87 (2):434-40.
264. Bauer TW, Schils J. The pathology of total joint arthroplasty. I. Mechanisms of implant fixation. *Skeletal Radiol*. 1999 Aug;28(8):423-32.
265. Guinness-Hey M, Hock JM. Loss of the anabolic effect of parathyroid hormone on bone after discontinuation of hormone in rats. *Bone*. 1989;10(6):447-52.
266. Ejersted C, Oxlund H, Eriksen EF, Andreassen TT. Withdrawal of parathyroid hormone treatment causes rapid resorption of newly formed vertebral cancellous and endocortical bone in old rats. *Bone*. 1998;23(1):43-52.
267. Rittmaster RS, Bolognese M, Ettinger MP, Hanley DA, Hodsmann AB, Kendler DL, et al. Enhancement of bone mass in osteoporotic women with parathyroid hormone followed by alendronate. *J Clin Endocrinol Metab*. 2000 Jun;85(6):2129-34.
268. Rowshan HH, Parham MA, Baur DA, McEntee RD, Cauley E, Carriere DT, et al. Effect of intermittent systemic administration of recombinant parathyroid hormone (1-34) on mandibular fracture healing in rats. *J Oral Maxillofac Surg*. 2010 Feb;68(2):260-7.
269. Doyan AR, Ferries IK, Li J. Glucocorticoid attenuates the anabolic effects of parathyroid hormone on fracture repair. *Calcif Tissue Int* 2010; 87-1:68-76.
270. Hashimoto T, Shigetomi M, Ohno T, Matsunaga T, Muramatsu K, Tanaka H, et al. Sequential treatment with intermittent low-dose human parathyroid hormone (1-34) and bisphosphonate enhances large-size skeletal reconstruction by vascularized bone transplantation. *Calcified Tissue International*. 2007 Sep;81(3):232-9.
271. Tada K, Yamamuro T, Okumura H, Kasai R, Takahashi H. Restoration of axial and appendicular bone volumes by h-PTH(1-34) in parathyroidectomized and osteopenic rats. *Bone*. 1990;11(3):163-9.
272. Takano Y, Tanizawa T, Mashiba T, Endo N, Nishida S, Takahashi HE. Maintaining bone mass by bisphosphonate incadronate disodium (YM175) sequential treatment after discontinuation of intermittent human parathyroid hormone (1-34) administration in ovariectomized rats. *J Bone MinerRes*. 1996;11(2):169-77.
273. Mosekilde L, Danielsen CC, Sogaard CH, McOsker JE, Wronski TJ. The anabolic effects of parathyroid hormone on cortical bone mass, dimensions and strength--assessed in a sexually mature, ovariectomized rat model. *Bone*. 1995;16(2):223-30.